

SHUTRADING

AUSTRALIA BEST FITNESS SUPPLIER

Welcome to Shu Trading Pty Ltd

If you have any questions or would like some valuable advice,
please feel free to contact us.

We're here to help 7 days a week!

Contact: Kathy

Tel: 02-9771 9298

Mobile: 0430 443 324

Fax: 02-9771 6098

Address: Unit A7/ 366 Edgar St., Condell Park, NSW 2200

Email: sales@shustrade.com.au

Web: www.shustrade.com.au

SHUTRADING
AUSTRALIA BEST FITNESS SUPPLIER

PRODUCT
CATALOGUE

2024 Vol. 1

2024 Vol. 1



SHU TRADING, AUSTRALIA

Your Gear, Your Body, Your Life



Shu Trading Pty Ltd

With focusing on sports and fitness equipment industry for over 10 years, and thanks for our valued customers' support, we are now supplying over 700 products in our high performance equipment range. We have grown into one of the biggest providers of strength and conditioning equipment in Australia.

At Shu Trading, we understand, it is more important than ever to find quality products at competitive prices, we and our factories have developed our products in three key points in mind.

- High Quality Raw Materials
- Superior Construction Methods
- Competitive Sale Price

To meet customers' various requirements, we also can make customers' special order

- Customer Color: Shu Trading can match team, club or school color.
- Customer Products: if you are looking for a particular item and you can not find it, please contact us.
- Custom Logos: Our factories can try to customize your products with your logo.

We have and continue to support our valued customers to build more prosperous business in our sports and fitness industry.

Most Recent Released

- 1) Air Bike & Spin Bike
- 2) Power Cage, CrossFit Rack, Attachments & RIG
- 3) Glute Ham Developer (GHD)
- 4) Multi-functional Storage Rack (Ultimate)
- 5) Farmers Walk Handle & Barbell Jack

Benches & Racks

- 1) FID Benches & Bench Press
- 2) Flat Bench, Sit up Bench
- 3) Squat Racks
- 4) Power Tower & Hyper Extension

Weights & Bars

- 1) OLY Weight Lifting: Bumper Plates & Mens and Ladies Bars
- 2) OLY Bars & Weights
- 3) STN Bars & Weights
- 4) Body Pump
- 5) Bar accessories

Cable Attachment

Dumbbells

- 1) Hex DB
- 2) Vinyl DB
- 3) Neoprene DB
- 4) Round DB
- 5) DB Handles
- 6) DB set
- 7) DB racks

Kettlebells

- 1) Competition Kettlebells
- 2) Vinyl coated kettlebells
- 3) Powder coated kettlebells
- 4) KB Rack

Medicine Balls

- 1) Medicine balls
- 2) Double-grip medicine balls
- 3) Wall Balls
- 4) Slam balls
- 5) MB Rack

CrossFit & Functional Training

- 1) Macebell
- 2) Clubbell
- 3) Battle Rope & Climbing Rope & Anchor
- 4) Functional Training
- 5) Grip Training
- 6) TRX & Parallette
- 7) Plyo Boxes
- 8) Power Sled
- 9) Weighted Bags & Bulgarian Bags
- 10) Torsonator
- 11) Weighted Vest & Ankle weights
- 12) Power Bands & Loop Band & Band Handle

Gym Flooring/Rubber Tiles

Yoga, Pilates & Balance

- 1) Gym balls & Bosu Ball
- 2) Foam Rollers
- 3) Yoga Exercise mats
- 4) Massage balls & stick
- 5) Resistance Band & Tubes
- 6) Other yoga accessories

Aerobic Fitness Bar & Step

- 1) Aerobic Steps
- 2) Aerobic Bars
- 3) Vibration Fitness Bar

Sports Training

- 1) Skipping ropes
- 2) Speed Agility & Hurdle
- 3) Other Sports Training

Gym Accessories

- 1) Gym Timer
- 2) Hand Grips
- 3) Dipping Belt & Head Harness
- 4) Other Gym accessories

Storage Racks

- 1) Ball Racks
- 2) Kettlebell Racks
- 3) Dumbbell Racks
- 4) Weights and Barbell Racks
- 5) Gym Bar racks
- 6) Ultimate Storage Racks

COMMERCIAL AIR BIKE

SKU:AB-HQ01-WT

SHUTRADING
AUSTRALIA BEST FITNESS SUPPLIER

KEY FEATURES:

COLOR:BLACK

ASSEMBLED: 130LX62WX123HCM

NET WEIGHT:55KG

USER WEIGHT CAPACITY: 150KG

PACKAGE SIZE: 132CM X 275CM X 89CM

PACKAGE WEIGHT:56KG

DRINK BOTTLE HOLDER

CRANKS:

CRANKS AXIAL CORE IS 12MM DIAMETER
AND 160MM LONG.

BELT:

EXTREMELY SMOOTH AND QUIET BELT

CHAIN:

DOUBLE CHAIN SYSTEM

TRANSPORT WHEEL:

STRONG POLYURETHANE TRANSPORT WHEEL.

COMPUTER: LCD SCREEN OUTPUTS:

WATTS-RPM-CALORIES-DISTANCE-TIME-INTERVAL
TRAINING (SET UP TARGET AND CUSTOM)

HANDLE BARS:

3.2MM STRONG HANDLE BARS WITH 40X80MM
HEXAGONAL HEAVY-DUTY FRAME

SEAT:

HIGH-QUALITY PU LEATHER RACING SEAT
ERGONOMICALLY WITH ADJUSTABLE HEIGHTS
& FORWARD BACK ALUMINUM ALLOY REGULATING TUBE

PEDALS:

COMMERCIAL ALLOY PEDALS WITH RUBBER PADS



◀ IF YOU HAVE ANY QUESTIONS OR WOULD LIKE SOME VALUABLE ADVICE,
PLEASE FEEL FREE TO CONTACT US.

WWW.SHUTRADE.COM.AU

SEMI-COMMERCIAL SPIN BIKE

SKU: SB-P40554-WT

SHUTRADING
AUSTRALIA BEST FITNESS SUPPLIER

KEY FEATURES:

COLOR:BLACK/RED

ASSEMBLED: 130LX60WX123HCM

NET WEIGHT:54KG

USER WEIGHT CAPACITY:150KG

PACKAGE SIZE:106M X 215CM X 86CM

PACKAGE WEIGHT:60KG

SEAT:

RACING SEAT ADJUSTABLE HEIGHTS
FORWARD/ BACK MADE WITH HIGH
QUALITY PU LEATHER.

HANDLE BARS:

ADJUSTABLE HEIGHTS & ADJUSTABLE FORWARD
BACK, TO SUIT ANY USER HEIGHT.

FRAME: SEMI-COMMERCIAL TUBULAR STEEL

CRANKS: STEEL WITH CHROME. CRANK ARM
LENGTH: 170CM

BELT:

EXTREMELY SMOOTH AND QUIET BELT

COMPUTER:

LCD SCREEN OUTPUTS: WATTS - RPM - CALORIES - HEART RATE
DISTANCE - TIME - ODOMETER - INTERVAL TRAINING (TABATA AND CUSTOM)

GRIP:

PROFESSIONAL MULTI-POSITION GRIP AND PRECISELY
ANGLED FOR OPTIMAL, EXERCISE SPECIFIC ERGONOMIC
POSITIONING.

FLY WHEEL:

22KG FLY WHEEL IN 460MM DIAMETER
WL PROTECTIVE COVER

PEDALS:

COMMERCIAL ALLOY PEDALS WITH RUBBER PADS
FOR GRIP, RACING STYLE WITH TOE CLIPS & STRAPS

TRANSPORT WHEEL:

STRONG POLYURETHANE TRANSPORT WHEEL.

DRINK BOTTLE HOLDER



◀ IF YOU HAVE ANY QUESTIONS OR WOULD LIKE SOME VALUABLE ADVICE,
PLEASE FEEL FREE TO CONTACT US.

WWW.SHUTRADE.COM.AU

POWER CAGE

SPECIFICATIONS AND FEATURES:

SOLID, COMPACT AND EFFECTIVE
COMMERCIAL GYM ENVIRONMENTS

ASSEMBLED DIMENSIONS:

101CM L X 118CM W X 210CM H (H0076 POWER CAGE LVY)

101CM L X 158CM W X 220CM H (H0076 & H0094 PACKAGE)

WEIGHT LOAD CAPACITY: POWER RACK=450KGS;

CHIN UP BARS=180KGS; DIP HANDLES= 180KGS

ACCEPTS EITHER STANDARD OR OLYMPIC SIZE WEIGHT PLATES

EB- H0076-NY POWER CAGE EB-H0094-NY CAGE ATTACHMENT

HEAVY DUTY 450KG LOAD
CAPACITY FOR POWER RACK

J-HOOKS WITH BARBELL PROTECTION

DIP BARS ARE ANGLED TO ISOLATE
CHEST AND TRICEPS

ADJUSTABLE HEIGHT DIP HANDLES

SPOTTER BARS FOR BARBELL PROTECTION

INDUSTRIAL CABLES WITH BEARING
DRIVEN PULLEYS

LAT TOWER RATED TO 160KGS

2.5" X 2.5" 11 GAUGE BLACK POWDER
COATED STEEL UPRIGHTS



IF YOU HAVE ANY QUESTIONS OR WOULD LIKE SOME VALUABLE ADVICE,
PLEASE FEEL FREE TO CONTACT US.

CROSSFIT RACK

SKU:EB-H0088-NY

SPECIFICATIONS AND FEATURES:

ASSEMBLED DIMENSIONS: 183CM L X 122CM W X 238CM H
WEIGHT LOAD CAPACITY: TOTAL RACK=400KGS; J HOOKS= 180KG;
SPOTTER BARS=200KGS
ACCEPTS EITHER STANDARD OR OLYMPIC SIZE WEIGHT PLATES
MULTI-FUNCTIONAL FREESTANDING RACK
EXTRA DEEP BASE: HELP PREVENTING THE RACK TIPPING

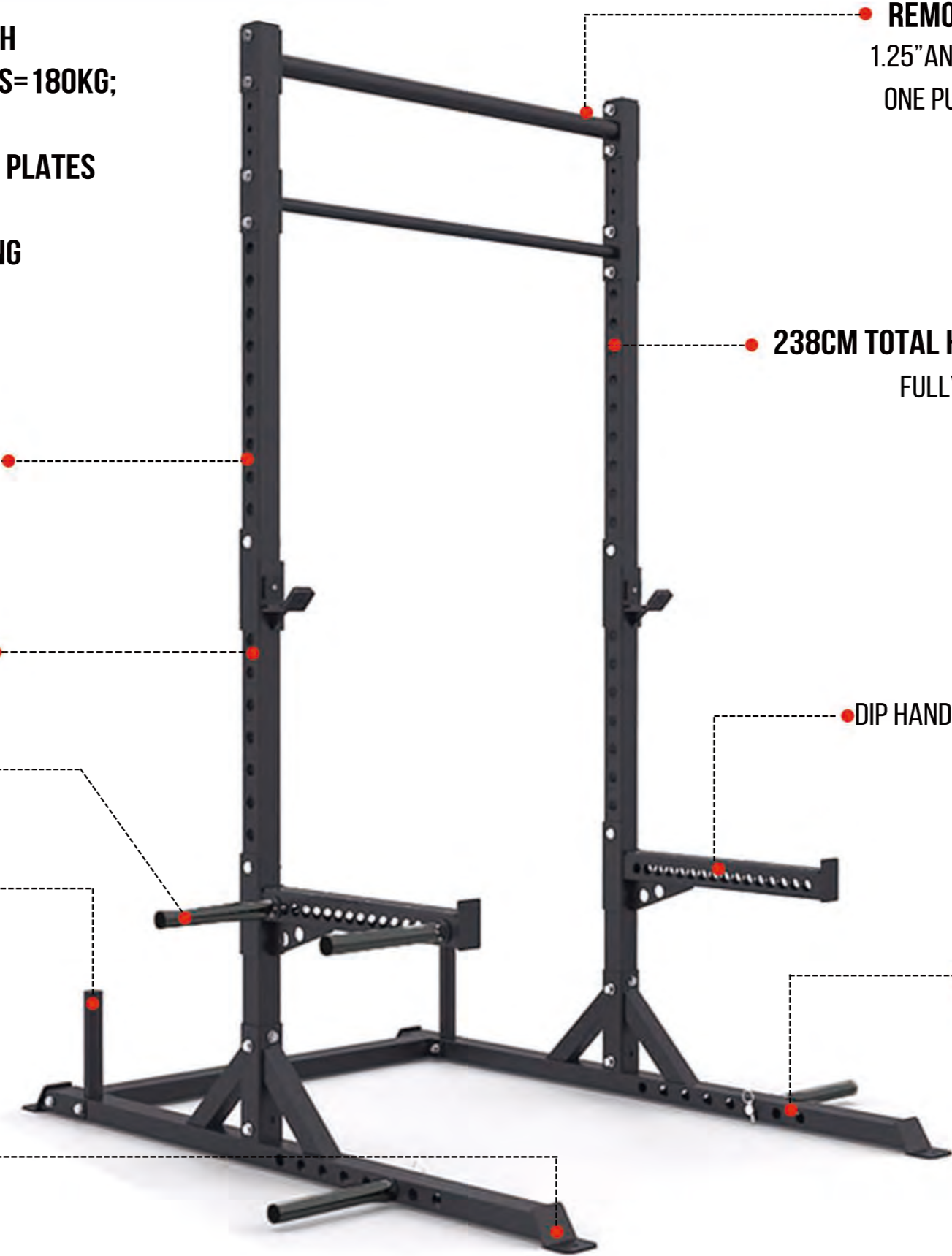

2.5"X2.5" 11 GAUGE BLACK POWDER COATE STEEL UPRIGHTS

ADJUSTABLE HEIGHT AND WIDTH DIP HANDLES

PLASTIC LINED SAFETY SPOTTER ARMS

PLATE STORAGE FOR EXTRA STABILITY 16CM HEIGHT

HOLES ON EVERY FOOT PLATE TO ALLOW
BOLTING INTO THE GROUND. NOT NECESSARY

● **REMOVEABLE FAT AND SKINNY PULL-UP BAR**
1.25" AND 2" LARGER DIMETER HELPS GRIP STRENGTH
ONE PULL UP BAR NECESSARY FOR RACK STABILITY

● **238CM TOTAL HEIGHT 183CM LENGTH & 122CM WIDTH**
FULLY ENCASED UPRIGHT AND A HIGHER SUPPORT
BRACE GIVES MORE SUPPORT TO UPRIGHTS
COMPARED TO OTHER FREE STANDING
SQUAT RACK WITH PULL UP BAR RACKS

● **DIP HANDLES DOUBLE AS BAND PEGS FOR RESISTANCE**
WORK WITH OUR STRENGTH BANDS

● **183CM LENGTH WITH FOOT PLATES HELPS**
MAINTAIN STABILITY FOR BENCHING
USING SAFETIES KIPPING PULL UPS
AND MUSCLES UPS

CROSSFIT RACK

SKU: EB-H0095-NY

Pull-Up
Max User Weight
up to 130kg

Dip Mount
Max User Weight
up to 100kg

Lat Pull Bar
Max User Weight
up to 80kg

Height Adjustable
Spotter
Max User Weight
up to 200kg

Roll Pull Bar
Max User Weight
up to 80kg

SPECIFICATIONS AND FEATURES:

ASSEMBLED DIMENSIONS: 83 X 65 X 230CM

WEIGHT LOAD CAPACITY: TOTALRACK=400KGS;J HOOKS=180KGS

SPOTTER BARS=200KGS

ACCEPTS EITHER STANDARD OR OLYMPIC SIZE WEIGHT PLATES

MULTI-FUNCTIONAL FREE STRNDING RACK

EXTRA DEEP BASE:HELP PREVENTING THE RACK TIPPING

IF YOU HAVE ANY QUESTIONS OR WOULD LIKE SOME VALUABLE ADVICE,
PLEASE FEEL FREE TO CONTACT US.



POWER CAGE / RIGS ACCESSORIES



INFINITY J-CUP SET

HEAVY DUTY LASER CUT AND PRECISION BENT DESIGN. UHMW PLASTIC INSERT PROTECTS YOUR BARS KNURLING FROM DAMAGE. NEW LOWER PROFILE DESIGN WITH ROUNDED CORNERS FOR SAFETY. BULLNOSE 5/8" PIN DESIGN FOR QUICK AND EASY ADJUSTMENTS. THESE J-CUPS WILL SUPPORT OVER 1000LB.

 PACKAGE SIZE: 32CM X 26CM X 10CM // PACKAGE WEIGHT: 6KG

SKU CF-BHRO-NL



SOUTH DIRTY BAR

THE DIRTY SOUTH BAR IS FEATURE A PAIR OF 1.25 DIAMETER BARS WITH GRIP-FRIENDLY, BLACK POWDER COAT FINISHES. THE TRIANGULAR DESIGN OF THE UNIT ALLOWS ATHLETES TO WORK FROM THE LOW OR HIGH POSITION BAR.

WEIGHT: 28KG / COLOR: BLACK / PACKAGE QTY: 1PC/CARTON

 PACKAGE SIZE: 178 CM L X 51CM W X 28CM H // PACKAGE WEIGHT: 28KG

SKU CF-TB6R-NL



INFIINITY SAFETY SPOTTER ARMS

WHETHER YOU DO MOST OF YOUR WEIGHTLIFTING IN A GARAGE GYM OR A LARGE-SCALE STRENGTH AND CONDITIONING FACILITY, A RELIABLE SET OF SPOTTING ARMS CAN ADD INSTANT PEACE OF MIND TO A TRAINING SPACE. THE INCLUSION OF UHMW PLASTIC LINERS ON ALL NEW ROGUE SAFETY SPOTTER ARMS ALSO ENSURES THE PROTECTION OF YOUR BARBELL FROM UNNECESSARY WEAR AND TEAR OVER TIME.

 PACKAGE SIZE: 76CM X 51CM X 11CM // PACKAGE WEIGHT: 17.5KG

SKU CF-SHRO-NL



43" DIRTY SOUTH BAR-SHORTY

CROSSFIT BEAN -MULTI

CREATING A CONVENIENT, MULTI-HEIGHT PULL-UP BAR IN ITS PLACE. THIS ADDED VERSATILITY IS PERFECT FOR GYMS WHERE MULTIPLE ATHLETES OF DIFFERENT SIZES ARE USING THE SAME EQUIPMENT.

DIMENSION: 110 CM L X 51CM W X 28CM H

 PACKAGE SIZE: 139CM X 59CM X 36CM // PACKAGE WEIGHT: 25KG

SKU CF-TB4R-NL

COMMERCIAL REVERSE HYPER

SKU: EB-RH01-NL

SHUTRADING
AUSTRALIA BEST FITNESS SUPPLIER

SPECIFICATIONS AND FEATURES:

THE REVERSE HYPEREXTENSION IS UNMATCHED WHEN IT COMES TO INCREASING STRENGTH, POWER, SPEED AND REACTION TIME IN THE POSTERIOR CHAIN

COMMERCIAL REVERSE HYPER EXTENSION

MADE FROM HEAVY DUTY 11 GAUGE STEEL (LOWER NUMBER = THICKER STEEL)

BLACK POWER COATING WITH BLACK UPHOLSTERY

UNIQUE DESIGN COMBINED WITH A STRONG COMPONENT OF INNOVATION, WHERE EVERY SINGLE DETAIL HAS BEEN CAREFULLY THOUGHT OUT IN ORDER TO PROVIDE ITS USERS WITH THE ULTIMATE WORKOUT EXPERIENCE.

USED FOR PHYSICAL THERAPY

THE REVERSE HYPER IS WIDELY USED IN MEDICAL THERAPY AND BACK EXERCISES

MADE OF IRON

THIS GYM EQUIPMENT OFFERS GREAT DURABILITY AS IT'S STRUCTURE IS MADE OF IRON AND OFFERS THE MOST COMFORT TO ITS ATHLETES WITH THE BEST DOUBLE STITCHED UPHOLSTERY.

WEIGHT RATING: 150KG

PACKAGE: 140CM L X 100CM W X 100CM H

PACK WEIGHT: 30KG

ASSEMBLED DIMENSIONS: 140 CM L X 100 CM W X 124 CM H



◀ IF YOU HAVE ANY QUESTIONS OR WOULD LIKE SOME VALUABLE ADVICE,
PLEASE FEEL FREE TO CONTACT US.

WWW.SHUTRADE.COM.AU

MULTI-FUNCTION STORAGE RACK

AS-7001-NL

#05 LONG HORIZONTAL BALL RACK
SKU : OT-SR05-NL

#02 LONG UPRIGHT FRAME
SKU : OT-SR02-NL

#01 SHORT UPRIGHT FRAME
SKU : OT-SR01-NL

#06 FLAT BOARD / KETTLEBELL RACK
SKU : OT-SR06-NL

#03 FRAME JOINT POLE
SKU : OT-SR03-NL

#07 TILT BOARD / DUMBBELLS RACK
SKU : OT-SR07-NL

#04 SHORT HORIZONTAL
BALL RACK
SKU : OT-SR04-NL

AS-7002-NL

#08 WHEEL
SKU : OT-SR08-NL



BENCH



MID WIDTH WEIGHT BENCH

THIS BENCH IS A GREAT COMPACT AND VERSATILE BENCH. IT IS PERFECT FOR THOSE WHO WANT TO WORKOUT AT HOME WITH LIMITED SPACE. HEAVY DUTY GAUGE FRAME, ADJUSTABLE 5 POSITIONS. FLAT, DECLINE AND INCLINE. HIGH QUALITY METALLIC POWDER COATING.

WEIGHT RATING: 140KG // ASSEMBLED SIZE: 174CM X 105CM X 126CM

 PACKAGE SIZE: 105CM X 62CM X 20CM // PACKAGE WEIGHT: 25KG

SKU EB-M807-NY



SIMPLE FID BENCH

THIS FID BENCH IS IDEA FOR HOME USE. IT IS ADJUSTABLE FROM FLAT TO INCLINE AND DECLINE POSITION.

WEIGHT RATING: 140KG // ASSEMBLED UP: 105CM X 39CM X 108CM
ASSEMBLED FLAT: 105CM X 39CM X 20CM

 PACKAGE SIZE: 108CM X 46CM X 23CM // PACKAGE WEIGHT: 10KG

SKU EB-M806-NY



COMMERCIAL FID BENCH

THIS COMMERCIAL FID BENCH IS HEAVY DUTY. FULLY ADJUSTABLE FLAT TO INCLINE AND DECLINE POSITIONS. DUAL REAR TRANSPORT WHEELS AND FRONT HANDLE ALLOW EASY MOVEMENT. OPTIONAL PREACHER CURL ATTACHMENT.

WEIGHT RATING: 275KG

ASSEMBLED UP: 155CM X 62CM X 143CM
ASSEMBLED FLAT: 155CM X 62CM X 55CM

 PACKAGE SIZE: 165CM X 68CM X 40CM // PACKAGE WEIGHT: 40KG

SKU EB-M808-NY



PORTABLE SQUAT RACK BARBELL STAND

THIS PORTABLE SQUAT RACK IS EASY TO ASSEMBLE AND ADJUSTABLE HEIGHT. IT IS IDEAL FOR HOME USE

WEIGHT RATING: 120KG // ASSEMBLED SIZE: 51CM X 53CM X 107CM TO 157CM

 PACKAGE SIZE: 110CM X 46CM X 27CM // PACKAGE WEIGHT: 20KG

SKU EB-P102-NY



COMMERCIAL SQUAT RACK

HIGH GRADE STEEL QUALITY
MANY INCREMENTAL ADJUSTMENTS FOR THE PERFECT HEIGHT REQUIRED FOR YOUR EXERCISE, SAFETIES FOR MAXIMUM SAFETY WHILE BENCH PRESSING
QUICK CHANGE BAR HOLDERS AND SAFETIES

WEIGHT RATING: 180KG // ASSEMBLED SIZE: 171CM X 93CM X 165CM

 PACKAGE SIZE: 165CM X 68CM X 40CM // PACKAGE WEIGHT: .35KG

SKU EB-P101-NY



SISSY SQUAT

MULTIPLE EXERCISE MACHINE: THIS 3-IN-1 LEG CURL MACHINE IS PERFECT FOR PERFORMING DEEP SISSY SQUATS, SIT-UPS, AND PUSH-UPS, TO WORK YOUR CORE, QUADS, GLUTES, AND CALVED FOR TRAINING AND CONDITIONING

WEIGHT RATING: 130KG // ASSEMBLED: 100CM X 80CM X 50CM

 PACKAGE SIZE: 93CM X 42CM X 45CM // PACKAGE WEIGHT: 18KG

SKU EB-SSQUAT-NL

BENCH



FLOOR GLUTE HAM DEVELOPER GHD

THE GLUTE HAM RAISE IS A VERY GOOD EXERCISE FOR THE DEVELOPMENT OF THE HAMSTRINGS AND GLUTES. OFTEN THIS EXERCISE IS NOT IMPLEMENTED IN TRAINING SCHEDULES BECAUSE NOT EVERYONE HAS THE RIGHT RESOURCES. THE GHD FLOOR GLUTE HAM DEVELOPER IS THE IDEAL TOOL TO PERFORM THAT EXERCISE. NOT ONLY IS THE GHD VERY COMPACT, IT IS ALSO A VERY STURDY PRODUCT FOR HOME FITNESS.

 PACKAGE QTY: 1PC/CARTON // PACKAGE WEIGHT: 15KG

SKU EB-FGHD-NL



HYPER EXTENSION (45 DEGREE)

THIS BENCH IS EXCELLENT FOR BACK WORKOUT, ADJUSTABLE THING PAD FOR PROPER POSITIONING & SUPPORT, HEAVY DUTY STEEL TUBE CONSTRUCTION. 45 DEGREE ANGLE FOR OPTIMAL RESULTS. HIGH QUALITY METALLIC POWDER COATING.

WEIGHT RATING: 150KG // ASSEMBLED SIZE: 130CM X 80CM 85CM

 PACKAGE SIZE: 48CM X 46CM X 25CM // PACKAGE WEIGHT: 20KG

SKU EB-H502-YL



DULEX POWER TOWER

OUR DULEX POWER TOWER IS STRONG ENOUGH FOR GYM USE. WHILE DESIGNED TO FIT INTO ANY HOME. IT IS HEAVY DUTY, HIGH DENSITY FOAM PADDING WRAPPED IN SEWN RIP-TOP UPHOLSTERY. PERFORM CHIN UPS, DIPS, PUSH UPS, SIT UPS AND LEG RAISES.

WEIGHT RATING: 135KG // ASSEMBLED SIZE: 135CM X 104CM X 213CM

 PACKAGE SIZE: 135.5CM X 46CM X 17CM // PACKAGE WEIGHT: 40KG

SKU EB-D506-YL



COMMERCIAL FLAT BENCH

THE COMMERCIAL FLAT BENCH IS AN ESSENTIAL PART OF ANY SERIOUS GYM SET UP THE BENCH IS MADE FROM THICK COMMERCIAL MAINFRAME COATED FRAME WITH BLACK UPHOLESTERY.

THE COMMERCIAL BENCH PRESS IS RATED TO CARRY 350KG OF LOAD WITH HIGH DENSITY FOAM AND IS WELL FINISHED.

WEIGHT RATING: 350KG // ASSEMBLED SIZE: 165CM X 50CM X 65CM

 PACKAGE SIZE: 150CM X 55CM X 30CM // PACKAGE WEIGHT: 25KG

SKU EB-W0200-NY



COMMERCIAL SITUP BENCH

THIS COMMERCIAL SIG-UP BENCH IS HEAVY DUTY. QUICK AND EASILY ADJUSTA THE ANGLE OF THE BENCH TO INCREASE OR DECREASE YOUR WORKOUT INTENSITY

WEIGHT RATING: 350KG // ASSEMBLED SIZE: 165CM X 50CM X 65CM

 PACKAGE SIZE: 165CM X 68CM X 40CM // PACKAGE WEIGHT: 25KG

SKU EB-W0199-NY



FLAT BENCH

HEAVY DUTY STEEL TUBE CONSTRUCTION
HIGH QUALITY METALLIC POWDER COATING
HIGH DENSITY DURABLE UPHOLSTERY

WEIGHT RATING: 180KG // ASSEMBLED SIZE: 120CM X 52CM X 50CM

 PACKAGE SIZE: 120CM X 46CM X 30CM // PACKAGE WEIGHT: 20KG

SKU EB-F603-YL

PREMIUM BARBELL & TIB BAR



TIBIALIS TRAINING BAR SOLO

DESIGNED TO PROVIDE YOU WITH GREAT WORKOUT SESSIONS FOR YEARS ON END, ADJUSTABLE, SINGLE FOOT TIB BAR NORDIC BENCH IS EXPERTLY CRAFTED USING HEAVY-DUTY STEEL CONSTRUCTION AND THICK FOAM CUSHIONS TO ENSURE LONG-LASTING, COMFORTABLE USE.

PACKAGE SIZE: 50CM X 30CM X 30CM // PACKAGE WEIGHT: 2KG

SKU EB-TB001-NL



TIBIALIS TRAINING BAR

THIS TIBIALIS ANTERIOR MACHINE IS WITH HAVE A STRONG STEEL CONSTRUCTION THAT IS INCREDIBLY DURABLE AND IDEAL FOR HOME AND COMMERCIAL USE. WE HIGHLY RECOMMEND USING THIS AS PART OF YOUR WORKOUT REGIMEN.

PACKAGE SIZE: 60CM X 35CM X 35CM // PACKAGE WEIGHT: 4KG

SKU EB-TB002-NL



MENS WEIGHT LIFTING BAR - BLACK

LOADING: 1500LB; BAR WEIGHT 20KG; BLACK ZINC
BAR LENGTH: 7FT; SLEEVE: 50MM (D); SHAFT: 28MM
ROTATION USING CLOSED 8 NEEDLE BEARING
HIGH-QUALITY ALLOY STEEL.
KNURLING ON THE BARS
SUITABLE FOR OLYMPIC PLATES (COLLARS NOT INCLUDED)

PACKAGE SIZE: 220CM X 10CM X 10CM // PACKAGE WEIGHT: 21KG

SKU PB-4001-NL



LADIES BARBELL

LOADING: 1000LB; BAR WEIGHT 15KG; HARD CHROME
BAR LENGTH: 6.8FT; SLEEVE: 50MM (D); SHAFT: 25MM
ROTATION USING CLOSED 4 NEEDLE BEARING
HIGH-QUALITY ALLOY STEEL.
KNURLING ON THE BARS
SUITABLE FOR OLYMPIC PLATES (COLLARS NOT INCLUDED)

PACKAGE SIZE: 210CM X 10CM X 10CM // PACKAGE WEIGHT: 16KG

SKU PB-4101-NL

OLYMPIC BUMPER PLATE

OLYMPIC RUBBER BUMPER PLATE

OLYMPIC RUBBER BUMP PLATES ARE IDEAL FOR CROSSFIT ATHLETES AND PERSONAL USERS

STANDARD INTERNATIONAL BUMP PLATE SIZE IN 45CM DIAMETER AND 2" HOLE
HEAVY DUTY, MADE FROM RUBBER

SOLID STEEL CENTRE HUB, EMBOSSED WITH KGS.

AVAILABLE IN DIFFERENT COLORS FOR EASY IDENTIFICATION



2.5KG SKU CODE: PO-3025-NL

DIMENSIONS: 7.5 X 7.5 X 3.5 CM

5KG SKU CODE: PO-2050-NL

DIMENSIONS: 45 X 45 X 3 CM

10KG SKU CODE: PO-2100-NL

DIMENSIONS: 45 X 45 X 4.2 CM

15KG SKU CODE: PO-2150-NL

DIMENSIONS: 45 X 45 X 6.5 CM

20KG SKU CODE: PO-2200-NL

DIMENSIONS: 45 X 45 X 8 CM

25KG SKU CODE: PO-2250-NL

DIMENSIONS: 45 X 45 X 9.5 CM

BLK OLY BUMPER PLATE



BLACK OLYMPIC RUBBER BUMP PLATE

OLYMPIC RUBBER BUMP PLATES ARE IDEAL FOR CROSSFIT ATHLETES AND PERSONAL USERS

STANDARD INTERNATIONAL BUMP PLATE SIZE IN 45CM DIAMETER AND 2" HOLE
HEAVY DUTY, MADE FROM RUBBER

SOLID STEEL CENTRE HUB, EMBOSSED WITH KGS.

2.5KG SKU CODE: PO-3025-NL

DIMENSIONS: 7.5 X 7.5 X 3.5 CM

5KG SKU CODE: PO-3050-NL

DIMENSIONS: 45 X 45 X 3 CM

10KG SKU CODE: PO-3100-NL

DIMENSIONS: 45 X 45 X 4.2 CM

15KG SKU CODE: PO-3150-NL

DIMENSIONS: 45 X 45 X 6.5 CM

20KG SKU CODE: PO-3200-NL

DIMENSIONS: 45 X 45 X 8 CM

25KG SKU CODE: PO-3250-NL

DIMENSIONS: 45 X 45 X 9.5 CM

BARBELL



OLYMPIC CURL BAR WITH COLLARS

LOADING:300LB; BAR WEIGHT 9KG;
BAR LENGTH: 47 INCH; SLEEVE: 50MM (D) ; SHAFT:28MM
ROTATION USING BUSHING
HIGH-QUALITY A3 STEEL.
KNURLING ON THE BARS
SUITABLE FOR OLYMPIC PLATES 2 INCHES CENTRE ONLY

 PACKAGE SIZE: 125CM X 8CM X 8CM // PACKAGE WEIGHT: 10KG

SKU PB-200C-NL



7FT OLYMPIC BAR W/ COLLARS, 300LB

LOADING:300LB; BAR WEIGHT 18KG;
BAR LENGTH: 7FT SLEEVE: 50MM (D) ; SHAFT:28MM
ROTATION USING BUSHING
HIGH-QUALITY A3 STEEL.
KNURLING ON THE BARS
SUITABLE FOR OLYMPIC PLATES 2 INCHES CENTRE ONLY

 PACKAGE SIZE: 220CM X 10CM X 10CM // PACKAGE WEIGHT: 20KG

300LB PB-2007-NL



5FT OLYMPIC BAR W/ COLLARS

LOADING:700LB; BAR WEIGHT 13KG;
BAR LENGTH: 5FT; SLEEVE: 50MM (D) ; SHAFT:30MM
ROTATION USING BUSHING
HIGH-QUALITY A3 STEEL.
KNURLING ON THE BARS
SUITABLE FOR OLYMPIC PLATES 2 INCHES CENTRE ONLY

 PACKAGE SIZE: 160CM X 10CM X 10CM // PACKAGE WEIGHT: 15KG

SKU PB-2005-NL



7FT OLYMPIC BAR W/ COLLARS, 700LB

LOADING:700LB; BAR WEIGHT 19KG;
BAR LENGTH: 7FT SLEEVE: 50MM (D) ; SHAFT:30MM
ROTATION USING BUSHING
HIGH-QUALITY A3 STEEL.
KNURLING ON THE BARS
SUITABLE FOR OLYMPIC PLATES 2 INCHES CENTRE ONLY

 PACKAGE SIZE: 220CM X 10CM X 10CM // PACKAGE WEIGHT: 20KG

700LB PB-2107-NL



6FT OLYMPIC BAR W/ COLLARS

LOADING:700LB; BAR WEIGHT 16KG;
BAR LENGTH: 6FT; SLEEVE: 50MM (D) ; SHAFT:30MM
ROTATION USING BUSHING
HIGH-QUALITY A3 STEEL.
KNURLING ON THE BARS
SUITABLE FOR OLYMPIC PLATES 2 INCHES CENTRE ONLY

PACKAGE SIZE:190CM X 10CM X 10CM // PACKAGE WEIGHT: 18KG

SKU PB-2006-NL



7FT OLYMPIC BAR W/ COLLARS, 1500LB

LOADING:1500LB; BAR WEIGHT 20KG;
BAR LENGTH: 7FT SLEEVE: 50MM (D) ; SHAFT:28MM
ROTATION USING BUSHING
HIGH-QUALITY SPRING STEEL.
KNURLING ON THE BARS
SUITABLE FOR OLYMPIC PLATES 2 INCHES CENTRE ONLY

 PACKAGE SIZE: 220CM X 10CM X 10CM // PACKAGE WEIGHT: 21KG

1500LB PB-2207-NL

BARBELL



OLYMPIC TRICEP BARBELL WITH COLLARS

CHROME PLATED OLYMPIC TRICEP BAR, TOTAL BAR LENGTH: 90CM
KNURL CENTRE HANDLES AND SOLID STEEL HANDLES. GRIP DIAMETER: 28MM
REVOLVING OLYMPIC SLEEVE: 50MM
SLEEVE LENGTH: 16CM
BAR WEIGHT: 10KG

PACKAGE SIZE: 86CM X 20CM X 6CM // PACKAGE WEIGHT: 11KG
SKU PB-2004-NL



OLYMPIC TRAINING BAR (8KG PINK BAR)

LOADING: 150LB; BAR WEIGHT 8KG;
BAR LENGTH: 6FT; SLEEVE: 50MM (D) ; SHAFT: 28MM
ROTATION USING BUSHING
HIGH-QUALITY ALUMINUM, OXIDE PINK.
KNURLING ON THE BARS
SUITABLE FOR OLYMPIC PLATES 2 INCHES CENTRE ONLY

PACKAGE SIZE: 183CM X 10CM X 10CM // PACKAGE WEIGHT: 9KG
SKU PB-4201-NL



OLYMPIC HEX TRAP BAR (DEADLIFTING BARBELL)

MADE AS A ONE-PIECE FORGED, SOLID CONSTRUCTION AND EFFECTIVE IN DESIGN, THE OLYMPIC HEX TRAP BAR IS PERFECT FOR EVERYDAY GYM USE, AND FOR A SNUG FIT IN THE HAND, HELPING TO HAVE INTENSE WORKOUTS FOR A VARIETY OF DIFFERENT MUSCLE GROUPS WHILE MAXIMIZING THE EFFECTIVENESS OF YOUR WORKOUTS WITH A COMBINATION OF CORE AND STRENGTH WORKOUTS
WEIGHT CAPACITY: 700LB;
BAR SLEEVE: 50MM; BAR LENGTH: 6FT (180CM). BAR WEIGHT: 27KG

PACKAGE SIZE: 185CM X 75CM X 20CM // PACKAGE WEIGHT: 27KG
SKU PB-2008-NL



OLYMPIC MULTI-GRIP BAR (FLAT STRONGMAN LOG)

THE OLYMPIC MULTI GRIP BAR, SWISS BAR, ADDS AN EXTRA DIMENSION TO YOUR STRENGTH WORKOUT. FEATURING ANGLED HANDLES, THE BAR OFFERS DIFFERENT GRIP VARIATIONS SO YOU CAN TARGET DIFFERENT MUSCLE GROUPS DURING YOUR WORKOUT, INCLUDING: WIDE NEUTRAL GRIP, NARROW NEUTRAL GRIP, ELBOWS IN GRIP, ELBOWS OUT GRIP..
WEIGHT CAPACITY: 700LB;
BAR SLEEVE: 50MM; GRIP DIAMETER: 32MM;
BAR LENGTH: 7FT (220CM). BAR WEIGHT: 21KG

PACKAGE SIZE: 213CM X 28CM X 9CM // PACKAGE WEIGHT: 22KG
SKU FE-2001-NL



OLYMPIC SAFETY SQUAT BAR

THE UNIQUE DESIGN OF THE OLYMPIC SAFETY SQUAT BAR ALLOWS THE BAR TO BE POSITIONED LOWER DOWN ON THE BACK/SHOULDERS. THE BAR IS PADDED WITH HEAVY-DUTY FOAM ROLLERS AND ADDED PROTECTION.

WEIGHT CAPACITY: 700LB;
BAR SHAFT: 28MM; BAR SLEEVE: 50MM
BAR LENGTH: 7FT (220CM). BAR WEIGHT: 27KG

PACKAGE SIZE: 220CM L X 50CM W X 10CM H, WEIGHT: 30KG
SKU PB-2019-NL



OLYMPIC DUMBBELL HANDLE

THE OLYMPIC DUMBBELL HANDLES ARE THE MOST DURABLE IN ITS CLASS AND PERFECT FOR HEAVY-DUTY WORKOUTS AND ARE AN IMPORTANT ADDITION TO ANY STRENGTH-CONDITIONING PROGRAM THAT REQUIRES A VARIETY OF EXERCISES. FEATURES: BRASS BUSHINGS; KNURLED HANDGRIP; CHROMED FINISH;
HANDLE SLEEVE: 50MM; HANDLE SHAFT: 32MM;
EACH HANDLE LENGTH: 20 INCH (54CM) AND WEIGHT: 6KG EACH

PACKAGE SIZE: 54CM X 8CM X 8CM // PACKAGE WEIGHT: 12KG
SKU DB-3000-NL

WEIGHT PLATE

OLYMPIC HAMMERTONE PLATE

WEIGHT PLATE IS A FLAT, HEAVY OBJECT, USUALLY MADE OF CAST IRON, THAT IS USED IN COMBINATION WITH BARBELLS OR DUMBBELLS TO PRODUCE A BAR WITH A DESIRED TOTAL WEIGHT FOR THE PURPOSE OF PHYSICAL EXERCISE.

1.25KG SKU CODE: PO-1012-CI

OLYMPIC SIZE IN HOLE DIAMETER OF 50MM
SIZE: 15CM DIAMETER X 2CM THICKNESS
PACK SIZE: 16CM X 32CM X 15CM
16PCS IN A CARTON

5KG SKU CODE: PO-1050-CI

OLYMPIC SIZE IN HOLE DIAMETER OF 50MM
SIZE: 23CM DIAMETER X 2.8CM THICKNESS
PACK SIZE: 25CM X 25CM X 12CM
4PCS IN A CARTON

15KG SKU CODE: PO-1150-CI

OLYMPIC SIZE IN HOLE DIAMETER OF 50MM
SIZE: 34.5CM DIAMETER X 3.9CM THICKNESS
PACK SIZE: 35CM X 36CM X 6CM
1PCS IN A CARTON

2.5KG SKU CODE: PO-1025-CI

OLYMPIC SIZE IN HOLE DIAMETER OF 50MM
SIZE: 18.5CM DIAMETER X 2.2CM THICKNESS
PACK SIZE: 22CM X 22CM X 20CM
8PCS IN A CARTON

10KG SKU CODE: PO-1100-CI

OLYMPIC SIZE IN HOLE DIAMETER OF 50MM
SIZE: 30.3CM DIAMETER X 3.5CM THICKNESS
PACK SIZE: 33CM X 33CM X 6CM
1PCS IN A CARTON

20KG SKU CODE: PO-1200-CI

OLYMPIC SIZE IN HOLE DIAMETER OF 50MM
SIZE: 38CM DIAMETER X 4.1CM THICKNESS
PACK SIZE: 40CM X 40CM X 6CM
1PCS IN A CARTON

25KG SKU CODE: PO-1250-CI

OLYMPIC SIZE IN HOLE DIAMETER OF 50MM
SIZE: 41CM DIAMETER X 4.3CM THICKNESS
PACK SIZE: 43CM X 43CM X 6CM
1PCS IN A CARTON

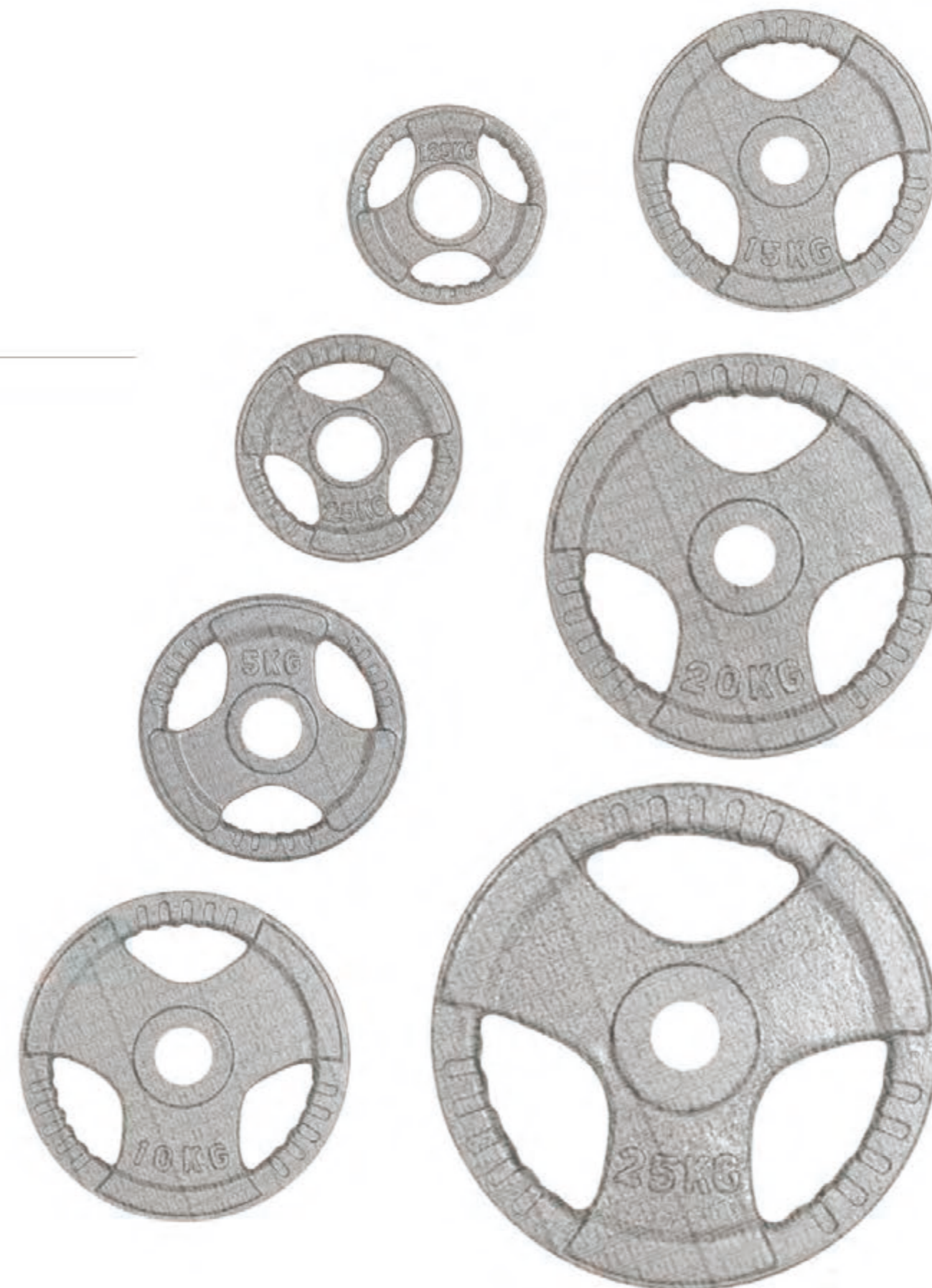

WEIGHT PLATE

OLYMPIC RUBBER COATED PLATE



1.25KG SKU CODE: PO-1012-RC

OLYMPIC SIZE IN HOLE DIAMETER OF 50MM
SIZE: 16CM DIAMETER X 3CM THICKNESS
PACK SIZE: 34CM X 20CM X 10CM
8PCS IN A CARTON

2.5KG SKU CODE: PO-1025-RC

OLYMPIC SIZE IN HOLE DIAMETER OF 50MM
SIZE: 20CM DIAMETER X 3.3CM THICKNESS
PACK SIZE: 42CM X 24CM X 10CM
8PCS IN A CARTON

5KG SKU CODE: PO-1050-RC

OLYMPIC SIZE IN HOLE DIAMETER OF 50MM
SIZE: 24CM DIAMETER X 4CM THICKNESS
PACK SIZE: 28CM X 28CM X 16CM
4PCS IN A CARTON

10KG SKU CODE: PO-1100-RC

OLYMPIC SIZE IN HOLE DIAMETER OF 50MM
SIZE: 32CM DIAMETER X 5CM THICKNESS
PACK SIZE: 34CM X 34CM X 10CM
2PCS IN A CARTON

15KG SKU CODE: PO-1150-RC

OLYMPIC SIZE IN HOLE DIAMETER OF 50MM
SIZE: 35.5CM DIAMETER X 5.2CM THICKNESS
PACK SIZE: 38CM X 38CM X 12CM
1PC IN A CARTON

20KG SKU CODE: PO-1200-RC

OLYMPIC SIZE IN HOLE DIAMETER OF 50MM
SIZE: 40CM DIAMETER X 5.4CM THICKNESS
PACK SIZE: 42CM X 42CM X 7CM
1PC IN A CARTON

25KG SKU CODE: PO-1250-RC

OLYMPIC SIZE IN HOLE DIAMETER OF 50MM
SIZE: 45CM DIAMETER X 5.5CM THICKNESS
PACK SIZE: 46CM X 46CM X 7CM
1PC IN A CARTON

BARBELL



STANDARD BARBELL SPRING COLLARS, 5FT - 7 FT

OUR STANDARD STRAIGHT BARBELLS COME WITH A PAIR OF SPRING COLLARS. COMMERCIAL GRADE KNURLING, ONE-PIECE FORGED CONSTRUCTION

SHAFTS: 5FT - 28MM (D) & 28CM (L) / 6FT - 28MM (D) & 32CM (L) / 7FT - 28MM (D) & 40CM (L)

 PACKAGE: ONE PIECE IN ONE PLASTIC BAG

5FT PB-1005-NL / WEIGHT: 8KG / SIZE: 152CM LENGTH X 28MM DIAMETER

6FT PB-1006-NL / WEIGHT: 10KG / SIZE: 182CM LENGTH X 28MM DIAMETER

7FT PB-1007-NL / WEIGHT: 11KG / SIZE: 213CM LENGTH X 28MM DIAMETER



EZY STANDARD CURL BAR W/ SPIN LOCKS

THIS STANDARD EZ CURL BAR IS CHROME PLATED SOLID STEEL BAR WITH KNURL GRIPS, FOR AN IMPROVED GRIPPING EXPERIENCE FOR USERS TO PERFORM FREE WEIGHTED BARBELL WORKOUTS SUCH AS DEADLIFTS, CURLS, SQUATS AND MORE. ONE-PIECE FORGED CONSTRUCTION. INCLUDING PAIR OF SPIN LOCK (STAR COLLARS)

BAR LENGTH: 47" (120CM); DIAMETER: 28MM

BAR WEIGHT: 5KG

 PACKAGE SIZE: 120CM X 28CM X 28CM // PACKAGE WEIGHT: 8KG

SKU PB-101C-NL



STANDARD BARBELL SPIN LOCK

OUR STANDARD STRAIGHT BARBELLS COME WITH A PAIR OF SPIN LOCKS. COMMERCIAL GRADE KNURLING. ONE-PIECE FORGED CONSTRUCTION.

SHAFTS: 5FT - 28MM (D) & 28CM (L) / 6FT - 28MM (D) & 32CM (L) / 7FT - 28MM (D) & 40CM (L)

 PACKAGE: 1 PIECE IN ONE PLASTIC BAG

5FT PB-1015-NL / WEIGHT: 8KG / SIZE: 152CM LENGTH X 28MM DIAMETER

6FT PB-1016-NL / WEIGHT: 10KG / SIZE: 182CM LENGTH X 28MM DIAMETER

7FT PB-1017-NL / WEIGHT: 11KG / SIZE: 213CM LENGTH X 28MM DIAMETER



EZY STANDARD CURL BAR W/ SPRING COLLARS

THIS STANDARD EZ CURL BAR IS CHROME PLATED SOLID STEEL BAR WITH KNURL GRIPS, FOR AN IMPROVED GRIPPING EXPERIENCE FOR USERS TO PERFORM FREE WEIGHTED BARBELL WORKOUTS SUCH AS DEADLIFTS, CURLS, SQUATS AND MORE. ONE-PIECE FORGED CONSTRUCTION. INCLUDING A PAIR OF SPRING COLLARS.

BAR LENGTH: 47" (120CM); DIAMETER: 28MM

BAR WEIGHT: 5KG

 PACKAGE SIZE: 120CM X 28CM X 28CM // PACKAGE WEIGHT: 8KG

SKU PB-100C-NL

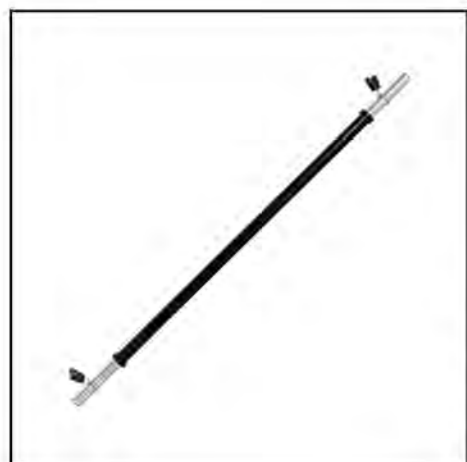

BODY PUMP BARBELL WITH COLLARS

BODY PUMP BARBELL WITH SPRING COLLARS

DIAMETER IS 30MM

QUICK RELEASE COLLARS (30MM) SOFT FOAM COVERED BAR

BAR DIMENSIONS: 150CM X 30MM

 PACKAGE SIZE: 150CM X 5CM X 5CM // PACKAGE WEIGHT: 3KG

SKU PB-3001-NL

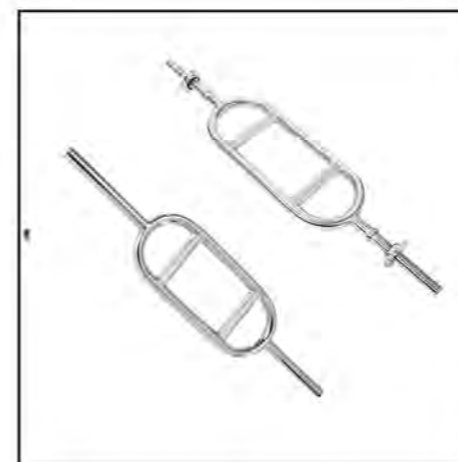

STANDARD TRICEP BAR

THIS STANDARD TRICEP BAR IS CHROME PLATED SOLID STEEL BAR WITH KNURL GRIPS, FOR AN IMPROVED GRIPPING EXPERIENCE FOR USERS TO PERFORM FREE WEIGHTED BARBELL WORKOUTS SUCH AS DEADLIFTS, CURLS, SQUATS AND MORE. INCLUDING A PAIR OF SPRING COLLARS.

BAR LENGTH: 86CM; SHAFT DIAMETER: 28MM

BAR WEIGHT: 5KG

 PACKAGE SIZE: 86CM X 20CM X 5CM // PACKAGE WEIGHT: 8KG

SKU PB-100T-NL

WEIGHT PLATE

SHUTRADING
AUSTRALIA BEST FITNESS SUPPLIER

STANDARD RUBBER COATED PLATE



1.25KG SKU CODE: PS-1012-RC

STANDARD SIZE IN HOLE DIAMETER OF 28MM
SIZE: 16CM DIAMETER X 3CM THICKNESS
PACK SIZE: 34CM X 20CM X 10CM
6PCS IN A CARTON

10KG SKU CODE: PS-1100-RC

STANDARD SIZE IN HOLE DIAMETER OF 28MM
SIZE: 32CM DIAMETER X 5CM THICKNESS
PACK SIZE: 34CM X 34CM X 10CM
2PCS IN A CARTON

2.5KG SKU CODE: PS-1025-RC

STANDARD SIZE IN HOLE DIAMETER OF 28MM
SIZE: 20CM DIAMETER X 3.3CM THICKNESS
PACK SIZE: 42CM X 24CM X 10CM
8PCS IN A CARTON

15KG SKU CODE: PS-1150-RC

STANDARD SIZE IN HOLE DIAMETER OF 28MM
SIZE: 35.5CM DIAMETER X 5.2CM THICKNESS
PACK SIZE: 38CM X 38CM X 12CM
1PCS IN A CARTON

5KG SKU CODE: PS-1050-RC

STANDARD SIZE IN HOLE DIAMETER OF 28MM
SIZE: 24CM DIAMETER X 4CM THICKNESS
PACK SIZE: 28CM X 28CM X 16CM
4PCS IN A CARTON

20KG SKU CODE: PS-1200-RC

STANDARD SIZE IN HOLE DIAMETER OF 28MM
SIZE: 40CM DIAMETER X 5.4CM THICKNESS
PACK SIZE: 42CM X 42CM X 7CM
1PCS IN A CARTON

IF YOU HAVE ANY QUESTIONS OR WOULD LIKE SOME VALUABLE ADVICE,
PLEASE FEEL FREE TO CONTACT US.

WWW.SHUTRADE.COM.AU

WEIGHT PLATE

STANDARD HAMMERTONE PLATE

WEIGHT PLATE IS A FLAT, HEAVY OBJECT, USUALLY MADE OF CAST IRON, THAT IS USED IN COMBINATION WITH BARBELLS OR DUMBBELLS TO PRODUCE A BAR WITH A DESIRED TOTAL WEIGHT FOR THE PURPOSE OF PHYSICAL EXERCISE.

0.5KG SKU CODE: PS-1005-CI

STANDARD SIZE IN HOLE DIAMETER OF 28MM
SIZE: 10CM DIAMETER X 1.5CM THICKNESS
PACK SIZE: 26CM X 18CM X 14CM
20PCS IN A CARTON

2.5KG SKU CODE: PS-1025-CI

STANDARD SIZE IN HOLE DIAMETER OF 28MM
SIZE: 18.5CM DIAMETER X 2.2CM THICKNESS
PACK SIZE: 22CM X 22CM X 20CM
8PCS IN A CARTON

1.25KG SKU CODE: PS-1012-CI

STANDARD SIZE IN HOLE DIAMETER OF 28MM
SIZE: 15CM DIAMETER X 2CM THICKNESS
PACK SIZE: 16CM X 32CM X 15CM
8PCS IN A CARTON

10KG SKU CODE: PS-1100-CI

STANDARD SIZE IN HOLE DIAMETER OF 28MM
SIZE: 30.3CM DIAMETER X 3.5CM THICKNESS
PACK SIZE: 33CM X 33CM X 6CM
2PCS IN A CARTON

5KG SKU CODE: PS-1050-CI

STANDARD SIZE IN HOLE DIAMETER OF 28MM
SIZE: 23CM DIAMETER X 2.8CM THICKNESS
PACK SIZE: 25CM X 25CM X 12CM
4PCS IN A CARTON

20KG SKU CODE: PS-1200-CI

STANDARD SIZE IN HOLE DIAMETER OF 28MM
SIZE: 38CM DIAMETER X 4.1CM THICKNESS
PACK SIZE: 40CM X 40CM X 6CM
1PCS IN A CARTON

15KG SKU CODE: PS-1150-CI

STANDARD SIZE IN HOLE DIAMETER OF 28MM
SIZE: 34.5CM DIAMETER X 3.9CM THICKNESS
PACK SIZE: 35CM X 36CM X 6CM
1PCS IN A CARTON



BODY PUMP & WEIGHT LIFTING BELT

SHUTRADING
AUSTRALIA BEST FITNESS SUPPLIER



BODY PUMP BARBELL SET

BODY PUMP BARBELL SET, OPTIONAL 20KG, 30KG & 40KG, INCLUDING
1 X SOFT RUBBER COVERED BAR WITH QUICK RELEASE COLLARS (30MM)
ANTI-ROLL DESIGN. 2-GRIPS COLOUR RUBBER COATED PLATES
1.25KG COLOURED PLATE (YELLOW)
2.5KG COLOURED PLATE (GREEN)
5KG COLOURED PLATE (ORANGE)
10KG COLOURED PLATE (PURPLE)

 PACKAGE SIZE: WEIGHTS AND BARS SEPARATELY

SKU PB-3000-NL



WEIGHT LIFTING BELT – S SIZE 105CM

TOP QUALITY LEATHER
SMOOTHER FINISH
CONTOURED SHAPE FOR COMFORTABLE FITTING
METAL STEEL ROLLER BUCKLE MAKES TENSIONING EASY
SOFT SUED LINING AND PADDING FOR COMFORT
REINFORCED DOUBLE STITCHING THROUGHOUT THE BELT // SIZE: 105CM

 PACKAGE SIZE: 50CM X 11CM // PACKAGE WEIGHT: 0.5KG

SKU WB-9001-HC

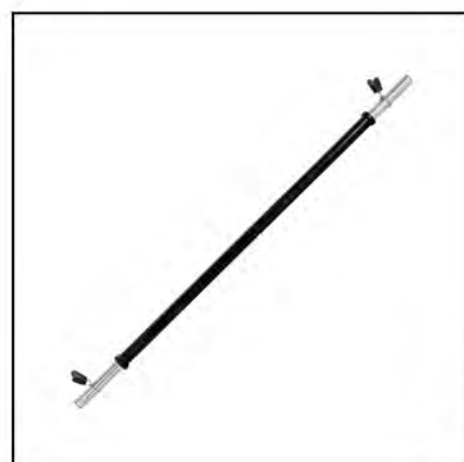

BODY PUMP BARBELL WITH COLLARS

BODY PUMP BARBELL WITH SPRING COLLARS
DIAMETER IS 30MM
QUICK RELEASE COLLARS (30MM) SOFT FOAM COVERED BAR
BAR DIMENSIONS: 150CM X 30MM

 PACKAGE SIZE: 150CM X 5CM X 5CM // PACKAGE WEIGHT: 3KG

SKU PB-3001-NL



WEIGHT LIFTING BELT – M SIZE 115CM

TOP QUALITY LEATHER
SMOOTHER FINISH
CONTOURED SHAPE FOR COMFORTABLE FITTING
METAL STEEL ROLLER BUCKLE MAKES TENSIONING EASY
SOFT SUED LINING AND PADDING FOR COMFORT
REINFORCED DOUBLE STITCHING THROUGHOUT THE BELT // SIZE: 115CM

 PACKAGE SIZE: 50CM X 11CM // PACKAGE WEIGHT: 0.5KG

SKU WB-9002-HC



BODY PUMP PLATE

BI-GRIPS ANTI-ROLL DESIGN COLOUR RUBBER COATED PLATES (THE DIAMETER
OF HOLE IS 30MM)
COMMERCIAL GRADE, RUBBER COATING IN COLORS
EMBOSSED WITH KGS

1.25KG PS-4012-RC

2.5KG PS-4025-RC

5KG PS-4050-RC

10KG PS-4100-RC



WEIGHT LIFTING BELT – L SIZE 125CM

TOP QUALITY LEATHER
SMOOTHER FINISH
CONTOURED SHAPE FOR COMFORTABLE FITTING
METAL STEEL ROLLER BUCKLE MAKES TENSIONING EASY
SOFT SUED LINING AND PADDING FOR COMFORT
REINFORCED DOUBLE STITCHING THROUGHOUT THE BELT // SIZE: 125CM

 PACKAGE SIZE: 50CM X 11CM // PACKAGE WEIGHT: 0.5KG

SKU WB-9003-HC

IF YOU HAVE ANY QUESTIONS OR WOULD LIKE SOME VALUABLE ADVICE,
PLEASE FEEL FREE TO CONTACT US.

WWW.SHUTRADE.COM.AU

BAR ACCESSORIES



STANDARD SPRING COLLAR

SPRING COLLAR, STANDARD
SUITED TO 28MM STANDARD BARBELL

PACKAGE WEIGHT: 0.2KG

SKU PC-1001-NL



OLMPIC LOCK JAW COLLAR

THIS COLLARS ARE STRONG AND EASY TO USE.

SUITED TO 50MM OLYMPIC BARBELL.

PACKAGE SIZE: 20CM X 10CM X 5CM // PACKAGE WEIGHT: 0.2KG

SKU PC-2005-NL



STANDARD STAR COLLAR

STAR COLLAR, STANDARD
SUITED TO 28MM STANDARD BARBELL

PACKAGE WEIGHT: .5KG

SKU PC-1002-NL



STANDARD LOCK JAW COLLAR

STANDARD LOCK JAW COLLAR IS MADE OF THE QUALITY INDUSTRY PLASTIC. THESE COLLARS ALLOW USERS SUPER-FAST WEIGHT PLATE CHANGES. SLIDES & LOCK ON AND OFF EASILY.

STANDARD SIZE 1 INCH
FITS ALL 28MM STANDARD BARS

PACKAGE SIZE: 15CM X 5CM X 5CM // PACKAGE WEIGHT: 0.1KG

SKU PC-1005-NL



PAIR OF OLYMPIC SPRING COLLAR

OLYMPIC SPRING COLLAR IS MADE OF THE HIGHEST QUALITY SPRING STEEL. THESE COLLARS ALLOW USERS SUPER-FAST WEIGHT PLATE CHANGES. HEAVY-DUTY CHROME SPRING COLLAR AND HANDLES SLIDES ON AND OFF EASILY OLYMPIC SIZE 2 INCH FITS ALL OLYMPIC BARS

PACKAGE SIZE: 42CM X 15CM X 6CM // PACKAGE WEIGHT: 0.5KG

SKU PC-2001-NL



MONSTER GRIPS

MONSTER GRIP ARE BEING USED BY THOUSANDS OF ATHLETES AND MILITARY AROUND THE WORLD FOR WEIGHT LIFTING, STRENGTH TRAINING AND POWER LIFTING, INCLUDING MEMBERS OF THE US SPECIAL FORCES, TEAMS IN THE NFL/MLB/NHL, TOP MMA FIGHTERS AND TOP BODYBUILDERS

PACKAGE SIZE: 12.5CM X 5CM // PACKAGE WEIGHT: 0.45KG/PAIR

SKU PG-1001-NL

BAR ACCESSORIES



PRO GRIP WRIST SUPPORT STRAPS

SIMPLE HANDLING BUT VERY EFFECTIVE. IDEAL FOR THE THE RELIEF OF THE FOREARMS AT PULLING EXERCISES. PERFECT FOR BODYBUILDER AND STRONGMAN. REINFORCED POWER LIFTER STRAPS. VELCRO FASTENING FOR PERFECT FIT. MADE FROM X-LARGE VELCRO FASTENERS. SOLID HEAVY DUTY STEEL HOOK. DIAMETER OF STEEL HOOK: 6MM. ONE SIZE FIT ALL. COLOR: BLACK

PACKAGE WEIGHT: 0.2KG/PAIR

SKU AG-3001-NL



WEIGHTLIFTING POWERLIFTING STRAPS

WEIGHTLIFTING POWERLIFTING STRAPS. EXCELLANT STRAPS FOR BODY BUILDING, WEIGHTLIFTING ,POWERLIFTING CROSS TRAINING AND WORKOUT. CHOICE OF SERIOUS TRAINERS ,POWER LIFTERS AND BODY BUILDERS. WEIGHT LIFTING STRAPS ARE USED TO GRIP ON EXERCISES LIKE DEAD LIFTS, SHRUGS AND CABLE ROWS. EAVY DUTY COTTON LIFTING STRAPS WITH NEOPRENE PADDING FOR SECURE GRIP ON THE BAR WHILE LIFTING.

PACKAGE SIZE: 10CM X 5CM X 3CM // PACKAGE WEIGHT: 0.1KG

SKU EA-9004-NL



WOODEN BARBELL JACK & HOLDER

DEADLIFT JACK CREATES EFFICIENT WEIGHTLIFTING EXERCISES AT HOME OR THE GYM. THE COMPACT AND PORTABLE DESIGN USES THE CONTACT WITH THE GROUND TO FORM A LEVER PRINCIPLE FOR EASY LIFTING. ITS ANGLED GROOVES MAKE SWITCHING WEIGHT PLATES SAFE AND EASY. WITH A CAPACITY OF 220KGS, THIS ACCESSORY ENSURES SAFETY DURING LOADING AND UNLOADING.

PACKAGE SIZE: 47.8X22X3.8CM // PACKAGE WEIGHT: 3KG

SKU FE-BJ02-NL



BARBELL SQUAT PAD, 40CM LENGTH

BUILT TO LAST HIGH QUALITY HEAVY-GAUGE DESIGN THAT SUPPORTS EVEN THE TOUGHEST OF WORKOUTS. ONE SIZE FITS ALL - STANDARD AND OLMPIC STRAIGHT BARBELLS. COMFORTABLE POLYESTER DESIGN FOR AN EASY WORKOUT.

PACKAGE SIZE: 40CM X 10CM X 10CM // PACKAGE WEIGHT: 0.5KG

SKU AP-7001-NL



7PCS BARBELL SQUAT SET WITH CARRY BAG

THICK BARBELL PROTECTIVE PAD PROTECTS THE NECK, SHOULDERS AND BACK DURING HEAVY SQUATS OR LUNGES. BARBELL PAD SECURING STRAPS ARE ADJUSTABLE STRAPS FOR BOTH OLYMPIC AND STANDARD SIZE BARBS. IT SECURES THE WEIGHTS NOT TO SLIP OUT OF THE PADS. CABLE MACHINE ANKLE ATTACHMENTS OR THE SO-CALLED PAIR OF ANKLE CUFF STRAP ATTACHMENT IS EASY TO CONNECT TO CABLE MACHINES AND HELPS YOU TONE YOUR GLUTES IN MAXIMUM COMFORT. THE STRAP ALLOWS YOU TO LOOSEN OR TIGHTEN THE CUFFS AND SECURE THE ANKLE AND WEIGHTS. FABRIC RESISTANCE BAND IS A HIGH QUALITY MAKE, ANTI-ROLL AND LASTS FOR A LONG TIME USE. WITH THE BOOTY EXERCISE, IT ENSURES IT STRENGTHEN GLUTES MUSCLES, INCREASES ENDURANCE, BALANCE AND FLEXIBILITY.

PACKAGE SIZE: 41CM X 11CM // PACKAGE WEIGHT: 0.5KG

SKU AP-7005-HC



POLY-FOAM BARBELL SQUAT PAD

40CM LENGTH
OUTSIDE DIAMETER: 110MM
INSIDE DIAMETER: 30MM
FIT FOR 1" STANDARD BARBELL AND 2" OLYMPIC BARBELL

PACKAGE SIZE: 41CM X 11CM X 11CM // PACKAGE WEIGHT: 0.5KG

SKU AP-7003-NL

CABLE ATTACHMENT



TRICEP ROPE

SOLID CONSTRUCTION AND EFFECTIVE IN DESIGN, THIS IS MADE FOR EVERYDAY GYM USE, AND DESIGNED TO FIT ON ANY CABLE EXERCISE EQUIPMENT. FEATURING HEAVY DUTY STEEL FOR STRUCTURAL INTEGRITY, THIS IS BUILT TO TAKE A POUNDING AND HELPS YOU EXPAND YOUR RANGE OF EXERCISES.

PACKAGE SIZE: 25CM X 25CM X 10CM // PACKAGE WEIGHT: 0.8KG

SKU EA-1001-NL



PREMIUM ANKLE STRAP

ATTACHED TO A LOW PULLEY FOR PERFORMING EXERCISES LIKE INNER AND OUTER THIGH AND GLUTE KICKBACKS. THE STRAP FEATURES HEAVY-DUTY NYLON CONSTRUCTION AND THE INSIDE OF THE ANKLE STRAP IS LINED WITH MAN-MADE WOOL PADDING FOR COMFORT; STRAP WIDTH: 7CM; STRAP LENGTH: 28CM (EXCLUDING D RING); D RING WIDTH : 4.5CM; PACK IN ONE PAIR

PACKAGE SIZE: 15CM X 15CM X 3CM // PACKAGE WEIGHT: 0.5KG

SKU EA-1004-NL



NYLON TRICEP STRAP

NYLON TRICEPS STRAP FEATURES EDGES THAT WON'T PINCH, SCRAPE OR CUT AND A PATENTED NEOPRENE LINING THAT ALLOWS HANDS TO BREATHE WHILE IN USE. BOTH CAN BE USED FOR TRICEPS PRESS DOWNS, AB CRUNCHES, BICEP CURLS, TRICEPS EXTENSIONS, FRONT AND SIDE

PACKAGE SIZE: 15CM X 15CM X 3CM // PACKAGE WEIGHT: 0.1KG

SKU EA-1002-NL



AB CRUNCH HANDLE

EXTRA-WIDE PADDED HARNESS PROTECTS THE NECK, SHOULDERS, BACK AND CHEST WHILE YOU CONCENTRATE ON YOUR ABS AND OBLIQUES. COMFORTABLE FOAM GRIPS OFFER QUICK AND EASY HAND POSITIONING. HEAVY-DUTY SOLID STEEL D RING FOR STRENGTH AND DURABILITY.

PACKAGE SIZE: 15CM X 15CM X 3CM // PACKAGE WEIGHT: 0.5KG

SKU EA-1005-NL



COMBO THIGH / ANKLE STRAP

COMPLETELY ADJUSTABLE WITH COMFORTABLE NEOPRENE LINING AND SURE-LOCK VELCRO CLOSURE, DESIGNED TO TARGET TRAIN THE HIPS, THIGHS AND BUTTOCKS;

PACKAGE SIZE: 10CM X 2CM X 2CM // PACKAGE WEIGHT: 0.2KG

SKU EA-1003-NL



NYLON WRIST STRAP

GET THE BENEFITS OF ANKLE AND WRIST STRENGTHENING EXERCISES WITH GREATER COMFORT AND EFFECTIVENESS THAN WITH WRIST OR ANKLE WEIGHTS. THE STRAP EASILY AND QUICKLY CONNECTS TO ANY CABLE-STYLE MACHINE TO DO EXERCISES THAT STRENGTHEN UPPER AND LOWER BODY.

PACKAGE SIZE: 15CM X 15CM X 3CM // PACKAGE WEIGHT: 0.1KG

SKU EA-1006-NL

CABLE ATTACHMENT



SINGLE HANDLE

PROFESSIONAL QUALITY SINGLE HANDLE CABLE ATTACHMENT IS CONSTRUCTED FROM SOLID STEEL, CHROMED PLATED AND FEATURES A RUBBER GRIP FOR EASE OF USE AND EXTRA COMFORT.

PACKAGE SIZE: 17CM X 15CM X 3CM // PACKAGE WEIGHT: 0.9KG

SKU EA-2001-NL



V-SHAPE TRICEP PRESS BAR

TRICEP PUSH DOWN BAR HELPS FOR A VARIETY OF DIFFERENT MUSCLE GROUPS WHILE MAXIMIZING THE EFFECTIVENESS OF YOUR WORKOUTS. IT IS SOLID STEEL CONSTRUCTION AND HIGHEST QUALITY WELDS FOR STRENGTH AND SAFETY. WITH TEXTURED RUBBER GRIPS, IT PREVENTS LOSS OF CONTROL.

PACKAGE SIZE: 28CM X 20CM X 9CM // PACKAGE WEIGHT: 2KG

SKU EA-3001-NL



SINGLE PADDED HANDLES

INDUSTRIAL STRENGTH NYLON HARD PLASTIC GRIP WITH THICK FOAM FOR COMFORT. GRIP MEASURE 12.5CM WIDE TO FIT ALL TYPES OF HANDS. HANDLE IS 135MM LENGTH X 30MM DIAMETER. WEBBING IS 25MM WIDTH X 250MM LENGTH. O SHAPE METAL RING IS 50MM DIAMETER.

PACKAGE SIZE: 15CM X 15CM X 3CM // PACKAGE WEIGHT: 0.1KG

SKU EA-2002-NL



CHIN TRIANGLE V-BAR

CHIN TRIANGLE V-BAR IS ALSO CALLED AS "CLOSE GRIP SEATED ROW /CHINNING BAR". USING THE "V" BAR ALLOWS YOU TO WORK WITH YOUR KNEES BENT AND PUTS YOUR BACK IN THE RIGHT POSITION ENABLING YOUR WORKOUT TO BE A LOT MORE EFFECTIVE. IT IS DESIGNED TO CLIP ON CABLE EXERCISE EQUIPMENT AND IS THE PERFECT BACK COMPOUND BACK TRAINING TOOL THAT WILL BUILD YOUR LATS AND UPPER BACK. WITH TEXTURED RUBBER GRIPS, IT PREVENTS LOSS OF CONTROL.

PACKAGE SIZE: 19CM X 15CM X 13CM // PACKAGE WEIGHT: 2KG

SKU EA-4001-NL



ADJUSTABLE NYLON STIRRUP HANDLE

ADJUSTABLE NYLON CABLE SINGLE HANDLE. HANDLE DIMENSIONS: 130MM LENGTH X 30MM DIAMETER. TOTAL LENGTH IS 335MM. 4 X O SHAPE METAL RING IS 30MM DIAMETER.

PACKAGE SIZE: 15CM X 15CM X 3CM // PACKAGE WEIGHT: 0.1KG

SKU EA-2003-NL



18" SOLID STRAIGHT BAR

18" REVOLVING STRAIGHT BAR WITH RUBBER GRIP IS PERFECT FOR TRICEPS PRESS DOWNS, STRAIGHT BAR CURLS, UPRIGHT ROWS, ARM PULLOVERS AND MORE. SMOOTH, FLUID CENTER FOR CONSTANT, STEADY MOTION.

PACKAGE SIZE: 50CM X 9CM X 4CM // PACKAGE WEIGHT: 2.5KG

SKU EA-5001-NL

CABLE ATTACHMENT



PRO GRIP CAP REVOLVING CURL BAR

BIOMECHANICALLY DESIGNED FOR THE MOST COMPLETE ARM DEVELOPMENT POSSIBLE. TWO SETS OF COMFORTABLE KNURL-TEXTURED RUBBER GRIPS ALLOW CLOSE-GRIP OR WIDE-GRIP CURLS AND TRICEPS PRESS DOWNS WITH FLAWLESS CONTROL AND BALANCE.
LENGTH: 77CM

PACKAGE SIZE: 80CM X 10CM X 10CM // PACKAGE WEIGHT: 3.6KG

SKU EA-6002-NL



WIDE DOUBLE-HANDLE REVOLVING ROW BAR

THE WIDE D-HANDLE REVOLVING ROW BAR IS DESIGNED TO GO WITH ANY MACHINE WITH A HIGH OR LOW PULLEY CABLE ATTACHMENT. WITH THIS BAR YOU CAN PERFORM WIDE HAMMER GRIP ROWS AND PULLDOWNS. YOU CAN ALSO USE THE STRAIGHT SECTION OF THE BAR FOR CLOSE GRIP ROWS AND PULLDOWNS CURLS AND PRESSDOWNS.

PACKAGE SIZE: 72CM X 18CM X 17CM // PACKAGE WEIGHT: 4.5KG

SKU EA-8001-NL



REVOLVING CLOSE GRIP LAT PULL DOWN BAR

LAT PULLDOWN BAR IS FEATURING HEAVY DUTY STEEL STRUCTURE. IT IS BUILT TO TAKE A POUNDING AND HELPS YOU EXPAND YOUR RANGE OF EXERCISES. AND IT PROVIDES SOME OF THE BEST, MOST EFFECTIVE CABLE EXERCISES. THE LAT BAR IS IN 125CM LONG.

PACKAGE SIZE: 125CM X 15CM X 5CM // PACKAGE WEIGHT: 5.2KG

SKU EA-6003-NL



PREMIUM AB SLING/ AB BLASTER

THESE SLINGS ENCOURAGE SUPERIOR TONING, TRIMMING AND CONDITIONING OF THE ENTIRE ABDOMINAL AREA WITHOUT LOWER BACK STRAIN. IN FACT, THEY CAN ACTUALLY HELP ABAD BACK BY STRETCHING THE MUSCLES AND DECOMPRESSING THE SPINE.
EACH IN SIZE OF: SIZE: 29CM L X 20CM W X 37CM H (HOOK IS 14CM LONG)

PACKAGE SIZE: 30CM X 22CM X 7CM // PACKAGE WEIGHT: 1.2KG

SKU EA-9003-NL



D-HANDLE ROW PULL DOWN BAR

THE D-HANDLE ROW BAR IS SOLIDLY CONSTRUCTED AND DESIGNED FOR OPTIMUM RESULTS. THIS HANDY VERSATILE DEVICE IS IDEAL FOR EVERYDAY USE AT THE GYM AND FITS PERFECTLY ON ANY CABLE EXERCISE EQUIPMENT. IT FEATURES HEAVY DUTY STEEL STRUCTURE AND IS BUILT TO LAST AND IT CAN STAND UP TO THE RIGORS OF ANY WORKOUT FROM BEGINNER TO ADVANCED USER.

PACKAGE SIZE: 35CM X 17CM X 19CM // PACKAGE WEIGHT: 3.5KG

SKU EA-7001-NL



NYLON DIPPING STRAP

THE NYLON DIPPING STRAPS ARE USED WITH ANY TYPE OF WEIGHTLIFTING BELT ALLOWING IT TO ALSO FUNCTION AS A DIPPING BELT. HEAVY-DUTY STEEL CHAIN WITH QUICK RELEASE SNAP LINK.

PACKAGE SIZE: 15CM X 15CM X 3CM // PACKAGE WEIGHT: 0.1KG

SKU EA-9005-NL

CABLE ATTACHMENT



SNAP LINK SNAP LINK WITH CHAIN LENGTH 73CM

 PACKAGE SIZE: 10CM X 6CM X 6 CM // PACKAGE WEIGHT: 0.3KG

 SKU AL-2001-NL



EASY GRIP ATTACHMENT SET (INCL. 5PCS)

EASY GRIP ATTACHMENT SET 5 PACK LAT ATTACHMENTS ARE THE PERFECT PULLEY ACCESSORY FOR YOU IF YOU ARE LOOKING TO DEVELOP YOUR UPPER AND MID BACK MUSCLES. WITH 5 DIFFERENTLY PLACED GRIPS THAT ISOLATE UNIQUE AND SPECIFIC BACK MUSCLES, WE'VE GOT YOUR BACK, LITERALLY. INCLUDED ARE TWO CLOSE-GRIP PRONATED GRIPS, AND THREE NARROW TO WIDE LENGTH NEUTRAL GRIP ATTACHMENTS.

 PACKAGE SIZE: 110CM X 50CM X 15CM // PACKAGE WEIGHT: 12KG

 SKU EA-9000-NL



SHU TRADING
**RUBBER COATED
 DUMBBELL**

PREMIUM QUALITY RUBBER COATED HEX DUMBBELLS.
 HEXAGONAL ENDS TO PREVENT ROLLING
 ERGONOMICALLY DESIGNED KNURLED CHROME CONTOUR HANDLES FOR ADDED
 COMFORT // EMBOSSED WEIGHT IDENTIFICATION IN KG

IDEAL FOR HOME OR GYM USE

- | | |
|--------------------------|--------------------------|
| 1KG DB-1010-RC | 17.5KG DB-1175-RC |
| 2KG DB-1020-RC | 20KG DB-1200-RC |
| 2.5KG DB-1025-RC | 22.5KG DB-1225-RC |
| 3KG DB-1030-RC | 25KG DB-1250-RC |
| 4KG DB-1040-RC | 27.5KG DB-1275-RC |
| 5KG DB-1050-RC | 30KG DB-1300-RC |
| 6KG DB-1060-RC | 32.5KG DB-1325-RC |
| 7KG DB-1070-RC | 35KG DB-1350-RC |
| 7.5KG DB-1075-RC | 37.5KG DB-1375-RC |
| 8KG DB-1080-RC | 40KG DB-1400-RC |
| 9KG DB-1090-RC | 42.5KG DB-1425-RC |
| 10KG DB-1100-RC | 45KG DB-1450-RC |
| 12.5KG DB-1125-RC | 47.5KG DB-1475-RC |
| 15KG DB-1150-RC | 50KG DB-1500-RC |
| | 55KG DB-1550-RC |



SHU TRADING
**VINYL COATED
 DUMBBELL**

PREMIUM QUALITY DUMBBELLS
 COLORFUL VINYL COATED AND MADE FROM CAST IRON
 HEXAGONAL ENDS TO PREVENT ROLLING
 PRINTED WEIGHT IDENTIFICATION IN KG

*COLOR MAY CHANGE WITHOUT NOTICE, PLEASE CHECK THE CURRENT COLOR WITH US
 IF NEED COLOR SPECIFIC.

- | |
|-------------------------|
| 0.5KG DB-5005-VL |
| 1KG DB-5010-VL |
| 1.5KG DB-5015-VL |
| 2KG DB-5020-VL |
| 2.5KG DB-5025-VL |
| 3KG DB-5030-VL |
| 4KG DB-5040-VL |
| 5KG DB-5050-VL |
| 6KG DB-5060-VL |
| 7KG DB-5070-VL |
| 8KG DB-5080-VL |
| 9KG DB-5090-VL |
| 10KG DB-5100-VL |



SHU TRADING
**NEOP. COATED
 DUMBBELL**

NEOPRENE HAND DIPPING DUMBBELL IS A GREAT HAND WEIGHT TO USE
 FOR ANY WORKOUT, NEOPRENE FINISH. GOOD TO USE WHILE POWER
 WALKIN, ONE-PEICE FORGED CONSTRUCTION, EMBOSSED WITH KG'
 SUITABLE FOR HOME OR COMMERCIAL USE

*COLOR MAY CHANGE WITHOUT NOTICE, PLEASE CHECK THE CURRENT COLOR WITH US
 IF NEED COLOR SPECIFIC.

- | |
|-------------------------|
| 0.5KG DB-6005-NL |
| 1KG DB-6010-NL |
| 1.5KG DB-6015-NL |
| 2KG DB-6020-NL |
| 2.5KG DB-6025-NL |
| 3KG DB-6030-NL |
| 4KG DB-6040-NL |
| 5KG DB-6050-NL |
| 6KG DB-6060-NL |
| 7KG DB-6070-NL |
| 8KG DB-6080-NL |
| 9KG DB-6090-NL |
| 10KG DB-6100-NL |

IF YOU HAVE ANY QUESTIONS OR WOULD LIKE SOME VALUABLE ADVICE,
 PLEASE FEEL FREE TO CONTACT US.

ROUND DUMBBELL

SHUTRADING
AUSTRALIA BEST FITNESS SUPPLIER

COMMERCIAL 10-40KG ROUND RUBBER DUMBBELL SET WITH RACK

PREMIUM QUALITY RUBBER COATED ROUND DUMBBELLS

ERGONOMICALLY DESIGNED KNURLED CHROME CONTOUR HANDLES FOR ADDED COMFORT

EMBOSSSED WEIGHT IDENTIFICATION IN KG

INCLUDES: ONE PAIR OF EACH 10KG, 12.5KG, 15KG, 17.5KG, 20KG, 22.5KG, 25KG, 30KG, 35KG, 40KG ROUND RUBBER DUMBBELLS AND ONE 2-TIERS DUMBBELL RACK

- TOTAL 10 PAIRS OF QUALITY RUBBER ROUND DUMBBELLS

TOTAL: 455KG FOR THE DUMBBELLS & ONE RACK

 **PACKAGE: DUMBBELLS AND RACK ARE PACKED SEPARATELY.**

SKU DB-7001-RC



**IF YOU HAVE ANY QUESTIONS OR WOULD LIKE SOME VALUABLE ADVICE,
PLEASE FEEL FREE TO CONTACT US.**

WWW.SHUTRADE.COM.AU

DUMBBELL & BARBELL SET



20KG ADJUSTABLE DUMBBELL SET WITHOUT 0.5KG

4 X 1.25KG STANDARD CAST IRON WEIGHT PLATE // 4 X 2.5KG STANDARD CAST IRON WEIGHT PLATE
2 X 14 INCH STANDARD DUMBBELL HANDLES WITH SPIN LOCK
DIAMETER: 28MM // PLATE: STANDARD 28MM CAST IRON
1 SET IN ONE CARTON

 PACKAGE SIZE: 30CM X 40CM X 10CM // PACKAGE WEIGHT: 20KG
SKU DB-2201-NL



50KG ADJUSTABLE DUMBBELL SET WITH CARRY CASE AND 6FT STANDARD BAR

INCL 4*5KG HAMMERTONE PLATE // 6*2.5KG HAMMERTONE PLATE // 4*1.25KG HAMMERTONE PLATE
2*16 INCH CHROME DUMBBELL HANDLE WITH SPIN LOCK // 1*6 FT CHROME BARBELL

DIAMETER: 28MM // PLATE: STANDARD 28MM CAST IRON
6FT BAR IS PACKED SEPARATELY

 PACKAGE SIZE1: 105CM X 30CM X 17CM // PACKAGE WEIGHT: 45KG
PACKAGE SIZE2: 185CM X 5CM X 5CM // PACKAGE WEIGHT: 5KG
SKU DB-2500-CI

DUMBBELL



STANDARD DUMBBELL HANDLES W/ STAR COLLAR

COME IN PAIR WITH PAIRS OF STAR COLLARS.

 PACKAGE: 1PIECE IN A PLASTIC BAG

- 14 INCH** DB-4002-NL // 36CM LENGTH X 28MM DIAMETER
- 16 INCH** DB-4003-NL // 40CM LENGTH X 28MM DIAMETER
- 19 INCH** DB-4005-NL // 48CM LENGTH X 28MM DIAMETER



2-LAYER DUMBBELL RACK FOR ROUND DUMBBELL

COMMERCIAL GRADE DUMBBELL STORAGE RACK INCLUDES CUP HOLDERS, CARRIES 10 PAIRS FIXED ROUND DUMBBELLS
WEIGHT RATING: 1000KG
ASSEMBLED SIZE: 230CM X 79CM X 55CM

 PACKAGE SIZE: C1-90CM X 85CM X 12CM // PACKAGE WEIGHT: 20KG
C2-108CM X 27CM X 12CM // PACKAGE WEIGHT: 40KG
SKU AS-3001-NL



OLYMPIC DUMBBELL HANDLE

THE OLYMPIC DUMBBELL HANDLES ARE THE MOST DURABLE IN ITS CLASS AND PERFECT FOR HEAVY-DUTY WORKOUTS AND ARE AN IMPORTANT ADDITION TO ANY STRENGTH-CONDITIONING PROGRAM THAT REQUIRES A VARIETY OF EXERCISES.
FEATURES: BRASS BUSHINGS; KNURLED HANDGRIP; CHROMED FINISH;
HANDLE SLEEVE: 50MM; HANDLE SHAFT: 32MM;
EACH HANDLE LENGTH: 20 INCH (54CM) AND WEIGHT: 6KG EACH

 PACKAGE SIZE: 54CM X 8CM X 8CM // PACKAGE WEIGHT: 12KG

SKU DB-3000-NL



3-TIERS DUMBBELL RACK

3 TIERS DESIGN
HEAVY GAUGE STEEL WITH ALL 4-SIDE WELDED CONSTRUCTION
ASSEMBLED SIZE: 1320MM(L) X 460MM(W) X 950MM(H)
WEIGHT RATING: 500KG

 PACKAGE: ONE RACK IN 2 FLAT BOXES
BOX1 SIZE: 124CM X 33CM X 17 CM & WEIGHT: 28KG
BOX2 SIZE: 97CM X 50CM X 11CM & WEIGHT: 10KG

SKU AS-3005-NL



2-LEVEL DUMBBELL RACK, FOR HEX DUMBBELLS

2 TIER DUMBBELL RACK FOR RUBBER HEX DUMBBELLS.
WEIGHT RATING: 500KG
ASSEMBLED SIZE: 73CM L X 50CM W X 77CM H

 PACKAGE SIZE: 83CM L X 25CM W X 10CM H WEIGHT: 13.5KG

SKU AS-3012-NL

DUMBBELL



TRIANGLE DUMBBELL RACK

TRIANGLE DUMBBELL RACK HOLDS 10 PAIR OF DUMBBELLS
OFFERS MAXIMUM DURABILITY AND BETTER PERFORMANCE IN LESS SPACE
ASSEMBLY SIZE: 65CM L X 55CM W X 145CM H

 PACKAGE SIZE: 145CM X 15CM X 13 CM WEIGHT 17KG

SKU AS-3003-NL



VERTICAL DUMBBELL RACK

THIS RACK CAN HOLD 10 PAIR DUMBBELL
BLACK COLOR CYLINDER WITH CHROME TOP CAP
ASSEMBLY SIZE: 55CM L X 55CM W X 125CM H
PACK: FLAT PACKED IN BOX

 PACKAGE SIZE: 124CM L X 52CM W X 25CM H WEIGHT 22KG

SKU AS-3002-NL



MINI DB RACK FOR 3 PAIRS DB

STRONG PLASTIC CONSTRUCTION SMALL DUMBBELL RACK, IDEAL STORAGE
FOR MINI & HEX DUMBBELL WEIGHTS, SMALL/COMPACT SIZE FOR FLOORS &
TABLETOPS – KEEPS WORKOUT AREAS NEAT & CLUTTER FREE, HOLDS UP TO
6, DUMBBELLS/3 PAIRS
WIDTH: 34CM – DEPTH: 9CM – HEIGHT: 34CM

 PACKAGE SIZE: 25CM L X 34CM W X 9CM H WEIGHT 500G

SKU AS-3011-NL

KETTLEBELL

COMPETITION KETTLEBELL

COMPETITION / PROFESSIONAL GRADE KETTLEBELLS ARE THE WORLD'S SINGLE MOST EFFECTIVE TOOL FOR MASSIVE GAINS IN STRENGTH, SPEED AND ATHLETIC ENDURANCE! KETTLEBELLS ARE MORE AND MORE POPULAR IN THE WORLD. THESE PRO-GRADE KETTLEBELLS ARE ERGONOMICALLY DESIGNED BY RUSSIA'S LEADING KETTLEBELLS LIFTERS AND COACHES. THEY ARE USED BY PROFESSIONAL KETTLEBELLS ATHLETES WORLD WIDE IN ALL INTERNATIONAL KETTLEBELL COMPETITIONS. SO, THESE PRO-GRADE KETTLEBELLS ARE ALSO NAMED AS COMPETITION KETTLEBELLS.



SHUTRADING
AUSTRALIA BEST FITNESS SUPPLIER

THE COMPETITION KETTLEBELLS ARE IN THE SAME DIMENSIONS THROUGHOUT THE RANGE *8, 10, 12, 16, 20, 24, 28, 32, KG.*

THEREFORE THERE IS NO NEED TO CHANGE TECHNIQUE WHEN MOVING BETWEEN WEIGHTS.

MADE FROM STEEL. THE WHOLE BODY AND HANDLES ARE ALL STEEL.

8KG	SKU: KB-3008-SL
10KG	SKU: KB-3010-SL
12KG	SKU: KB-3012-SL
16KG	SKU: KB-3016-SL
20KG	SKU: KB-3020-SL
24KG	SKU: KB-3024-SL
28KG	SKU: KB-3028-SL
32KG	SKU: KB-3032-SL

- ALL COMPETITION KETTLEBELLS ARE IN SAME SIZE REGARDLESS OF THE WEIGHTS
- DIFFERENT WEIGHT IN DIFFERENT COLOR
- EMBOSSED WITH KGS
- MADE BY STEEL & SUITABLE FOR HOME OR COMMERCIAL USE
- SIZE AVAILABLE: 8 / 10 / 12 / 16 / 20 / 24 / 28 / 32

IF YOU HAVE ANY QUESTIONS OR WOULD LIKE SOME VALUABLE ADVICE, PLEASE FEEL FREE TO CONTACT US.

WWW.SHUTRADE.COM.AU

KETTLEBELL

VINYL KETTLEBELL

KETTLEBELLS ARE THE WORLD'S SINGLE MOST EFFECTIVE TOOL FOR MASSIVE GAINS IN STRENGTH, SPEED AND ATHLETIC ENDURANCE! KETTLEBELLS DELIVER STRENGTH, ENDURANCE AND RAPID WEIGHT LOSS WITHOUT THE DISHONOR OF AEROBICS AND DIETING.

WITHIN A FEW WEEKS, YOU CAN EXPECT TO SEE SPECTACULAR GAINS IN OVERALL STRENGTH AND CONDITIONING - AND FOR MANY- SIGNIFICANT FAT LOSS! OUR NEW-LOOK KETTLEBELLS ARE IN EXCELLENT QUALITY. THEY ARE DESIGNED TO HAVE RUBBER BASE AT THE BOTTOM, TO AVOID DAMAGE TO THE FLOOR.



OUR NEW-LOOK KETTLEBELLS ARE IN EXCELLENT QUALITY.

THEY ARE DESIGNED TO HAVE RUBBER BASE AT THE BOTTOM, TO AVOID DAMAGE TO THE FLOOR.

4, 6, 8, 10, 12, 16, 20, 24KG.

4KG	SKU: KB-2004-VL
6KG	SKU: KB-2006-VL
8KG	SKU: KB-2008-VL
10KG	SKU: KB-2010-VL
12KG	SKU: KB-2012-VL
16KG	SKU: KB-2016-VL
20KG	SKU: KB-2020-VL
24KG	SKU: KB-2024-VL

- HIGH-QUALITY VINYL COATD KETTLEBELL
- VINYL COATED BODY LOOKS SHINY & SMOOTH
- RUBBER BASE AT THE BOTTOM
- EMBOSSED WITH KGS, DIFFERENT WEIGHT IN DIFFERENT COLOR
- SUITABLE FOR HOME OR COMMERCIAL USE
- SIZE AVAILABLE: 4 / 6 / 8 / 10 / 12 / 16 / 20 / 24

KETTLEBELL

KETTLEBELLS ARE THE WORLD'S SINGLE MOST EFFECTIVE TOOL FOR MASSIVE GAINS IN STRENGTH, SPEED AND ATHLETIC ENDURANCE! KETTLEBELLS DELIVER STRENGTH, ENDURANCE AND RAPID WEIGHT LOSS WITHOUT THE DISHONOR OF AEROBICS AND DIETING. WITHIN A FEW WEEKS, YOU CAN EXPECT TO SEE SPECTACULAR GAINS IN OVERALL STRENGTH AND CONDITIONING - AND FOR MANY- SIGNIFICANT FAT LOSS! GET YOURS TODAY! OUR NEW-LOOK KETTLEBELLS ARE IN EXCELLENT QUALITY. FINISHED OFF WITH PREMIUM BLACK POWDER COATING .-- HANDLES ARE FINISHED OFF WITH COLOURED BANDS FOR EASY IDENTIFICATION OF WEIGHT SIZES IN ACCORDANCE WITH INTERNATIONAL STANDARDS . -- MANUFACTURED FROM ONE SOLID PIECE OF IRON RATHER THAN MULTIPLE WELDED PIECES, WHICH CREATES AN EVEN STRONGER, ROBUST KETTLEBELL.



CLASSIC KETTLEBELL



4KG	SKU: KB-1004-NL	- HIGH-QUALITY RUSSIAN STYLE KETTLEBELLS
6KG	SKU: KB-1006-NL	- FINISHED OFF WITH PREMIUM BLACK POWDER COATING .
8KG	SKU: KB-1008-NL	- EMBOSSED WITH KGS
10KG	SKU: KB-1010-NL	- SUITABLE FOR HOME OR COMMERCIAL USE
12KG	SKU: KB-1012-NL	- SIZE AVAILABLE:
16KG	SKU: KB-1016-NL	4,6,8,10,12,16,20,24,28,32,36,40,44,48KG
20KG	SKU: KB-1020-NL	
24KG	SKU: KB-1024-NL	
28KG	SKU: KB-1028-NL	
32KG	SKU: KB-1032-NL	
36KG	SKU: KB-1036-NL	
40KG	SKU: KB-1040-NL	
44KG	SKU: KB-1044-NL	
48KG	SKU: KB-1048-NL	

◀ IF YOU HAVE ANY QUESTIONS OR WOULD LIKE SOME VALUABLE ADVICE, PLEASE FEEL FREE TO CONTACT US.

KETTLEBELL RACK



KETTLEBELL RACK

2 TIER KETTLEBELL RACK THAT IS PERFECT FOR KEEPING YOUR KETTLEBELLS OFF THE GROUND AND OUT OF THE WAY. THE TWO TIER SYSTEM ALLOWS EASY ACCESS AND A LARGER STORAGE CAPACITY. A GOOD KETTLEBELL STORAGE RACK HELPS TO KEEP YOUR GYM TIDY AND SAFE.

WEIGHT RATING: 500KG

ASSEMBLY SIZE: 138CM L X 52CM W X 75CM H



PACKAGE SIZE: C1 139CM L X 27CM W X 6CM H, WEIGHT: 17KG

C2 76CM L X 52CM W X 12CM H, WEIGHT: 10KG

SKU AS-2001-NL

MEDICINE BALL

COMMERCIAL MEDICINE BALL



- / COMMERCIAL GRADE MEDICINE BALLS
- / TWO TONE COLOR DESIGN
- / EXTREMELY DURABLE & TEXTURED SURFACE IS EASY TO GRIP
- / EMBOSSED WITH KGS
- / SIZE AVAILABLE: 2KG - 10KG, IN 1KG INCREMENT

2KG	SKU: MN-2002-HC // DIAMETER: 19CM // PACKAGE SIZE: 20CM X 20CM X 20CM // WEIGHT: 2KG
3KG	SKU: MN-2003-HC // DIAMETER: 23CM // PACKAGE SIZE: 25CM X 25CM X 25CM // WEIGHT: 3KG
4KG	SKU: MN-2004-HC // DIAMETER: 23CM // PACKAGE SIZE: 25CM X 25CM X 25CM // WEIGHT: 4KG
5KG	SKU: MN-2005-HC // DIAMETER: 23CM // PACKAGE SIZE: 25CM X 25CM X 25CM // WEIGHT: 5KG
6KG	SKU: MN-2006-HC // DIAMETER: 29CM // PACKAGE SIZE: 30CM X 30CM X 30CM // WEIGHT: 6KG
7KG	SKU: MN-2007-HC // DIAMETER: 29CM // PACKAGE SIZE: 30CM X 30CM X 30CM // WEIGHT: 7KG
8KG	SKU: MN-2008-HC // DIAMETER: 29CM // PACKAGE SIZE: 30CM X 30CM X 30CM // WEIGHT: 8KG
9KG	SKU: MN-2009-HC // DIAMETER: 29CM // PACKAGE SIZE: 30CM X 30CM X 30CM // WEIGHT: 9KG
10KG	SKU: MN-2010-HC // DIAMETER: 29CM // PACKAGE SIZE: 30CM X 30CM X 30CM // WEIGHT: 10KG

DOUBLE-GRIP MEDICINE BALL



- / DOUBLE HANDLES MAKE FOR AN EASIER GRIP, AND INCREASE THE NUMBER OF EXERCISES YOU CAN DO
- / EASIER TO USE THAN A STANDARD MEDICINE BALL
- / EXTREMELY DURABLE
- / BLACK COLOR ONLY
- / SIZE AVAILABLE: 3KG - 10KG, IN 1KG INCREMENT

3KG	SKU: MD-1003-SP // DIAMETER: 23CM // PACKAGE SIZE: 25CM X 25CM X 25CM // WEIGHT: 3KG
4KG	SKU: MD-1004-SP // DIAMETER: 23CM // PACKAGE SIZE: 25CM X 25CM X 25CM // WEIGHT: 4KG
5KG	SKU: MD-1005-SP // DIAMETER: 27CM // PACKAGE SIZE: 29CM X 29CM X 29CM // WEIGHT: 5KG
6KG	SKU: MD-1006-SP // DIAMETER: 27CM // PACKAGE SIZE: 29CM X 29CM X 29CM // WEIGHT: 6KG
7KG	SKU: MD-1007-SP // DIAMETER: 27CM // PACKAGE SIZE: 29CM X 29CM X 29CM // WEIGHT: 7KG
8KG	SKU: MD-1008-SP // DIAMETER: 27CM // PACKAGE SIZE: 29CM X 29CM X 29CM // WEIGHT: 8KG
9KG	SKU: MD-1009-SP // DIAMETER: 27CM // PACKAGE SIZE: 29CM X 29CM X 29CM // WEIGHT: 9KG
10KG	SKU: MD-1010-SP // DIAMETER: 27CM // PACKAGE SIZE: 29CM X 29CM X 29CM // WEIGHT: 10KG

WALL BALL



3KG	SKU: MN-3003-HC // DIAMETER: 35CM // PACKAGE SIZE: 36CM X 36CM X 36CM // WEIGHT: 3KG
4KG	SKU: MN-3004-HC//DIAMETER: 35CM // PACKAGE SIZE: 36CM X 36CM X 36CM// WEIGHT: 4KG
5KG	SKU: MN-3005-HC // DIAMETER: 35CM // PACKAGE SIZE: 36CM X 36CM X 36CM // WEIGHT: 5KG
6KG	SKU: MN-3006-HC // DIAMETER: 35CM // PACKAGE SIZE: 36CM X 36CM X 36CM // WEIGHT: 6KG
7KG	SKU: MN-3007-HC // DIAMETER: 35CM // PACKAGE SIZE: 36CM X 36CM X 36CM // WEIGHT: 7KG
8KG	SKU: MN-3008-HC //DIAMETER: 35CM // PACKAGE SIZE: 36CM X 36CM X 36CM// WEIGHT: 8KG
9KG	SKU: MN-3009-HC // DIAMETER: 35CM // PACKAGE SIZE: 36CM X 36CM X 36CM // WEIGHT: 9KG
10KG	SKU: MN-3010-HC // DIAMETER: 35CM // PACKAGE SIZE: 36CM X 36CM X 36CM // WEIGHT: 10KG
12KG	SKU: MN-3012-HC // DIAMETER: 35CM // PACKAGE SIZE: 36CM X 36CM X 36CM // WEIGHT: 12KG



/ SOFT MEDICINE BALL LAYERED WITH FOAM, WEIGHTED AND LEATHER COVERED
/ DIAMETER APPROX. 14 INCHES WIDE (35CM)
/ IDEAL FOR VARIETY OF CARDIO, STRENGTH BUILDING, CROSSFIT AND STRENGTH EXERCISES
/ BALL IS TO BE USED TO THROW AGAINST A WALL
/ SIZE AVAILABLE: 3,4,5,6,7,8,9,10,12KG

IF YOU HAVE ANY QUESTIONS OR WOULD LIKE SOME VALUABLE ADVICE,
PLEASE FEEL FREE TO CONTACT US.

SLAM BALL

THE NON-BOUNCE SLAM BALLS ARE INTENDED FOR FUNCTIONAL RESISTANCE TRAINING EXERCISES VARYING DIFFICULTY FOR ANY FITNESS, SPORT, OR REHABILITATION APPLICATION. THIS IS THE PERFECT BALL FOR EXERCISES SUCH AS WOOD CHOPS, OVERHEAD THROWS AND MUCH MORE. BALL SLAM EXERCISES HELP YOU GAIN EXPLOSIVE STRENGTH, MUSCLE STRENGTH AND TONE THE ENTIRE BODY; FROM YOUR SHOULDERS ALL THE WAY DOWN TO YOUR LEGS. ADDITIONALLY, USING SLAM BALLS WILL FORCE YOU TO DO A VARIETY OF CHALLENGING MOVEMENTS THAT WILL INCREASE CARDIOVASCULAR ACTIVITY AND AID IN WEIGHT LOSS.

3KG	SKU: MN-4003-HC // PACKAGE SIZE: 28CM (L) X 28CM (W) X 28CM (H) // WEIGHT: 3KG
4KG	SKU: MN-4004-HC // PACKAGE SIZE: 28CM (L) X 28CM (W) X 28CM (H) // WEIGHT: 4KG
5KG	SKU: MN-4005-HC // PACKAGE SIZE: 28CM (L) X 28CM (W) X 28CM (H) // WEIGHT: 5KG
6KG	SKU: MN-4006-HC // PACKAGE SIZE: 28CM (L) X 28CM (W) X 28CM (H) // WEIGHT: 6KG
7KG	SKU: MN-4007-HC // PACKAGE SIZE: 28CM (L) X 28CM (W) X 28CM (H) // WEIGHT: 7KG
8KG	SKU: MN-4008-HC // PACKAGE SIZE: 28CM (L) X 28CM (W) X 28CM (H) // WEIGHT: 8KG
9KG	SKU: MN-4009-HC // PACKAGE SIZE: 28CM (L) X 28CM (W) X 28CM (H) // WEIGHT: 9KG
10KG	SKU: MN-4010-HC // PACKAGE SIZE: 28CM (L) X 28CM (W) X 28CM (H) // WEIGHT: 10KG
12KG	SKU: MN-4012-HC // PACKAGE SIZE: 28CM (L) X 28CM (W) X 28CM (H) // WEIGHT: 12KG
15KG	SKU: MN-4015-HC // PACKAGE SIZE: 33CM (L) X 33CM (W) X 33CM (H) // WEIGHT: 15KG
20KG	SKU: MN-4020-HC // PACKAGE SIZE: 33CM (L) X 33CM (W) X 33CM (H) // WEIGHT: 20KG
25KG	SKU: MN-4025-HC // PACKAGE SIZE: 35CM (L) X 35CM (W) X 35CM (H) // WEIGHT: 25KG
30KG	SKU: MN-4030-HC // PACKAGE SIZE: 38CM (L) X 38CM (W) X 38CM (H) // WEIGHT: 30KG



◀ IF YOU HAVE ANY QUESTIONS OR WOULD LIKE SOME VALUABLE ADVICE, PLEASE FEEL FREE TO CONTACT US.

BALL RACK



SINGLE-SIDE MEDICINE BALL RACK

SINGLE-SIDE MEDICINE BALL STAND
WHITE COLOR ONLY
HOLD 5 BALLS
ASSEMBLY SIZE: 45CM L X 33CM W X 139CM H

 PACKAGE SIZE: 139CM L X 34CM W X 12 CM H // PACKAGE WEIGHT: 8KG
SKU AS-1100-NL



DOUBLE-SIDE RACK FOR BALL AND BAG

THE PERFECT STORAGE UNIT AND ORGANIZER FOR POWER BAGS AND MEDICINE BALLS

- IT CAN HOLDS 5 BALLS AND 5 BAGS
- ATTRACTIVE MODERN DESIGN FITS ANY DECOR.
- DURABLE BLACK POWDER COATED FINISH

 PACKAGE SIZE: 50CM L X 25CM W X 155CM H // PACKAGE WEIGHT: 10KG
SKU AS-1210-NL

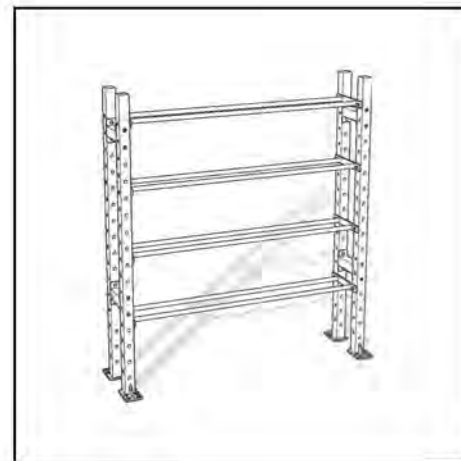

MULTI-FUNCTIONAL RACK FOR BALLS

YOU CAN DESIGN A STORAGE RACK FOR BALLS



DOUBLE-SIDE MEDICINE BALL RACK

DOUBLE-SIDE MEDICINE BALL STAND
WHITE COLOR ONLY
HOLD 10 BALLS
ASSEMBLY SIZE: 45CM L X 33CM W X 139CM H

 PACKAGE SIZE: 139CM L X 34CM W X 12 CM H // PACKAGE WEIGHT: 8KG
SKU AS-1200-NL

MACEBELL STEEL MACE



THE STEEL MACE IS A VERY CHALLENGING AND EXCITING PIECE OF EQUIPMENT TO MASTER. MANY OF THE EXERCISES ARE BEST PERFECTED AT A LOWER WEIGHT, SO IF YOU ARE PLANNING TO UTILIZE THE FULL GAMUT OF POSSIBILITIES WE RECOMMEND STARTING WITH A LIGHT WEIGHT (2KG) AND WORKING UP.

AVAILABLE WEIGHTS

2KG	SKU CODE: CB-2002-NL SIZE: 80CM L X 9CM W X 9CM H
4KG	SKU CODE: CB-2004-NL SIZE: 98CM L X 9CM W X 9CM H
6KG	SKU CODE: CB-2006-NL SIZE: 100CM L X 10CM W X 10CM H
8KG	SKU CODE: CB-2008-NL SIZE: 102CM L X 11CM W X 11CM H
10KG	SKU CODE: CB-2010-NL SIZE: 106CM L X 12CM W X 12CM H

CLUBBELL / INDIA CLUB



- 2KG** SKU CODE: CB-1002-HC SIZE: 41CM L X 6CM W X 5CM H
- 4KG** SKU CODE: CB-1004-HC SIZE: 45CM L X 6CM W X 5CM H
- 6KG** SKU CODE: CB-1006-HC SIZE: 50CM L X 7CM W X 7CM H
- 8KG** SKU CODE: CB-1008-HC SIZE: 54CM L X 9CM W X 9CM H
- 10KG** SKU CODE: CB-1010-HC SIZE: 59CM L X 9.5CM W X 9.5CM H

CLUBBELL IS A UNIQUE TOOL FOR CROSS TRAINING AND PROVIDES A UNIQUE BLEND OF FUNCTIONAL, FULL-RANGE, THREE-DIMENSIONAL MUSCULAR DEVELOPMENT THAT STANDS IN CONTRADISTINCTION TO THE PROBLEMATIC LIMITATIONS OF CONVENTIONAL TWO-DIMENSIONAL LINEAR TRAINING.

BATTLE & CLIMBING ROPE



SISAL FITNESS BATTLE ROPE, 2" THICK

BATTLE ROPE TRAINING PROVIDES FULL UPPER BODY TRAINING, TARGETING THE CORE, SHOULDERS AND ARMS.

OUR SIAL BATTLE ROPE HAS BEEN MANUFACTURED FROM PREMIUM GRADE SISAL FIBRE TO GIVE IT GREATER FLEXIBILITY AND PREVENT SHEDDING THAT OCCURS WITH HARSHER FIBRES SUCH AS HEMP. IT IS DESIGNED TO WITHSTAND HEAVY FREQUENT USE. THESE BATTLE ROPES ARE IDEALLY SUITED FOR ALL COMMERCIAL AND HOME GYM USE. IN 2" THICKNESS

SIZE AVAILABLE: 10M, 15M AND 20M

 PACKAGE SIZE: 66CM L X 27CM W X 32CM H

10M AR-8010-NL **15M** AR-8015-NL **20M** AR-8020-NL



2" PP BATTLE ROPE

BATTLE ROPE TRAINING PROVIDES FULL UPPER BODY TRAINING, TARGETING THE CORE, SHOULDERS AND ARMS.

OUR BATTLE ROPE IS DESIGNED TO WITHSTAND HEAVY FREQUENT USE IDEALLY SUITED FOR ALL COMMERCIAL AND HOME GYM USE.

WITH TOUGH BLACK NYLON CASING TO ELIMINATE ROPE WEAR AND FIBRE SHEDDING HEAVY DUTY END CAPS BOLTED THROUGH ROPEBUILD POWER AND STRENGTH ENDURANCE IN 2" THICKNESS

SIZE AVAILABLE: 10M, 15M AND 20M.

 PACKAGE SIZE: 70CM L X 27CM W X 32CM H

10M AR-5010-NL **15M** AR-5015-NL **20M** AR-5020-NL



7M PP CLIMBING ROPE, WITH HOOP

ROPE CLIMBING HAS BEEN A FOUNDATION EXERCISE IN MANY STYLES OF TRAINING. IT IS ONE OF THE BEST UPPER-BODY STRENGTH EXERCISES AVAILABLE TO YOU. OUR 1.5" THICKNESS PP CLIMBING ROPE IS PERFECT FOR BUILDING FOREARM AND GRIP STRENGTH, AS WELL AS TARGETING YOUR CORE AND BACK. CLIMBING A ROPE IS SUCH A SIMPLE ACTION, BUT HIGHLY EFFECTIVE FOR PHYSICAL DEVELOPMENT.

 PACKAGE SIZE: 66CM L X 27CM W X 23 CM H, WEIGHT: 7KG

SKU AR-6007-NL



1.5" PP BATTLE ROPE

BATTLE ROPE TRAINING PROVIDES FULL UPPER BODY TRAINING, TARGETING THE CORE, SHOULDERS AND ARMS.

OUR BATTLE ROPE IS DESIGNED TO WITHSTAND HEAVY FREQUENT USE IDEALLY SUITED FOR ALL COMMERCIAL AND HOME GYM USE.

WITH TOUGH BLACK NYLON CASING TO ELIMINATE ROPE WEAR AND FIBRE SHEDDING HEAVY DUTY END CAPS BOLTED THROUGH ROPEBUILD POWER AND STRENGTH ENDURANCE IN 1.5" THICKNESS

SIZE AVAILABLE: 10M, 15M AND 20M.

 PACKAGE SIZE: 66CM L X 27CM W X 32CM H

10M AR-6010-NL **15M** AR-6015-NL **20M** AR-6020-NL



7M SISAL CLIMBING ROPE, WITH HOOP

ROPE CLIMBING HAS BEEN A FOUNDATION EXERCISE IN MANY STYLES OF TRAINING. IT IS ONE OF THE BEST UPPER-BODY STRENGTH EXERCISES AVAILABLE TO YOU. THIS 1.5" THICKNESS SISAL CLIMBING ROPE IS PERFECT FOR BUILDING FOREARM AND GRIP STRENGTH, AS WELL AS TARGETING YOUR CORE AND BACK. CLIMBING A ROPE IS SUCH A SIMPLE ACTION, BUT HIGHLY EFFECTIVE FOR PHYSICAL DEVELOPMENT.

 PACKAGE SIZE: 66CM L X 27CM W X 23CM H, WEIGHT: 6KG

7M AR-8007-NL



BATTLE ROPE ANCHOR

REDUCE TANGLES
PREVENT ROPES FROM COMING FREE
INCREASED SAFETY FOR OTHERS
PERFECT TO KEEP YOUR STUDIO TIDY
DYNABOLTS AND FITTING ACCESSORIES INCLUDED ;
30CM L X 8CM W X 4.5CM H, WEIGHT: 1KG;

PACKAGE SIZE: 31CM L X 16CM W X 6CM H, WEIGHT: 1.2KG

SKU AR-5001-NL



BATTLE BAR WITH TWO EARS

SLIDE TRAINING ROPE INTO THE END OF THE BAR TO DO ROWS, SLAMS, WHIPS AND MORE

- ROPES EASILY SELF-LOOP INTO PLACE
- DOUBLE BAR MEASURES 50 INCH LONG AND HAS A 32MM GRIP
- OPENING IN BARS MEASURES 2.2" (MAXIMUM ROPE THAT WILL FIT IN BATTLE)

PACKAGE SIZE: 15CM X 96CM X 7CM // PACKAGE WEIGHT: 4KG

SKU FE-3002-NL



BATTLE ROPE WALL HANGER

SMOOTH POWDER COATED STEEL WON'T DAMAGE YOUR ROPE.
LONG ANGULAR HOOK HANGER MAKES COILING AND STORAGE EASY.
CAN BE INSTALLED IN DRYWALL OR CONCRETE.
DIMENSIONS: BASE IS 25 X 6.5CM, ROPE HOOK STICKS OUT 35CM, TOTAL 30CM OF HANGING SPACE, AND 10CM LIP.
WEIGHT: 1KG

PACKAGE SIZE: 25CM L X 25CM W X 7CM H, WEIGHT: 1KG

SKU AR-5002-NL



EXTREME CORE TRAINER

THE EXTREME CORE TRAINER, ALSO CALLED AS TORSONATOR, IS A GREAT PIECE OF EQUIPMENT FOR ALL TYPES OF ROTATIONAL TORSO TRAINING. IT IS GOOD FOR FUNCTIONAL STRENGTH TRAINING AND ALSO SUITED FOR A RANGE OF UPPER BODY TRAINING. INCLUDING V BAR, THE MULTI-DIRECTIONAL SWIVEL ALLOWS YOU TO DO ROTATIONAL EXERCISES AND PRESSES.

BAR V-SHAPE HANDLE INCLUDED.

1 SET IN A CARTON

PACKAGE SIZE: 50CM X 50CM X 40CM // PACKAGE WEIGHT: 20KG

SKU TR-1001-NL



VIPR FITNESS TUBE

VIPR FITNESS TUBE PROVIDES AN EFFECTIVE, WHOLE BODY WORKOUT, BUILDS MUSCLE AND BURNS CALORIES THROUGH STRENGTH AND MOVEMENT TRAINING. LIFT, DRAG, THROW OR STEP ON VIPR - ANY MOVEMENT IS SUITABLE FOR ALL AGES AND ABILITIES. THE VIPR FITNESS TUBES ARE MADE OF RUBBER, SO IT IS VIRTUALLY INDESTRUCTIBLE AND INCREDIBLY FUNCTIONAL

SKU
FE-5004-NL 4KG POWER BARREL, PURPLE
FE-5006-NL 6KG POWER BARREL, RED
FE-5008-NL 8KG POWER BARREL, BLUE
FE-5010-NL 10KG POWER BARREL, DARK GREEN
FE-5012-NL 12KG POWER BARREL, DARK BLUE

PACKAGE SIZE: 165CM X 14CM X 14CM



UNEARTHED CORE TRAINER

THE LANDMINE UNEARTHED IS DESIGNED TO BE ANCHORED BY AN OLYMPIC PLATE (50MM DIAMETER SLOT), USING IT AS A BASE. IT IS A CHEAPER VERSION OF THE TORSONATOR WITH BASE PLATE (USING WEIGHT DISCS INSTEAD OF A BASE) AND MORE PORTABLE.

* WEIGHT PLATES NOT INCLUDED.

PACKAGE SIZE: 30CM X 15CM X 10CM // PACKAGE WEIGHT: 3KG

SKU TR-1101-NL

FUNCTIONAL TRAINING



GODZILLA CHIN UP BAR 5 WAY

5 WAY GRIP CHIN UP, HEAVY DUTY FRAME, 1200MM WIDTH, 50MM MOUNTING PLATES, DYNABOLTS INCLUDED

250 KG WEIGHT LOADING

PACKAGE SIZE: 120CM X 80CM X 60CM // PACKAGE WEIGHT: 8KG

SKU AR-2003-NL



DOG BONE PULL-UP BAR, IN PAIR

DOG BONE HAS TWO UNIQUE SURFACES FOR GRIP WORK. USE THE EXTRA FAT 3" CENTER SECTION OR CHALLENGE YOUR FINGERS WITH THE SPHERICAL ENDS. THE STRAP CAN BE ATTACHED TO A PULL-UP BAR OR KETTLEBELL. USE CHAIN TO ATTACH IT TO BUMPERS OR CAST IRON WEIGHT PLATES.

PACKAGE SIZE: 40CM X 20CM X 7CM // PACKAGE WEIGHT: 2KG

SKU PG-1004-NL



GYMNASTIC RING, BLACK

OUR GYM RINGS ARE MADE FROM DURABLE, EASY-GRIP PLASTIC AND INCLUDE HEAVY DUTY NYLON RING STRAPS. IT CAN BE SET UP FOR INDOOR AND OUTDOOR BODYWEIGHT TRAINING IN ALMOST ANY CONDITIONS.

RING DIAMETER: 23.5CM; MAX WEIGHT SUPPORT: 500KG; EACH STRAP IS 6 METER LONG

PACKAGE SIZE: 28CM X 26CM X 8CM // PACKAGE WEIGHT: 1KG

SKU GR-1002-NL



GRANDFATHER CLOCK GRIP, IN PAIR

GRANDFATHER CLOCK GRIP IS A NEW TAKE ON THE CLASSIC TOWEL GRIP PULL-UP. SOLD IN PAIRS, THESE 1.875" DIAMETER STEEL TUBES CAN DELIVER A MORE INTENSE FORM OF BODYWEIGHT TRAINING THAN A TRADITIONAL PULL-UP BAR, AS THE VERTICAL NEUTRAL GRIP POSITION NOT ONLY IS A GRIP STRENGTH KILLER, BUT ALSO TARGETS THE FOREARM MUSCLES MUCH IN THE WAY A ROPE CLIMB DOES.

PACKAGE SIZE: 20CM X 20CM X 10CM // PACKAGE WEIGHT: 1.8KG

SKU PG-1006-NL



WOODEN GYMNASTIC RING

OUR WOOD RING PROVIDES A SOLID FOUNDATION FOR GYMNASTIC STRENGTH BUILDING AND BEGINNER-TO-ADVANCED SUSPENSION TRAINING. WOOD IS OFTEN THE BEST CHOICE FOR INDOOR SETUPS. WITH A TEXTURED, GRIP-FRIENDLY SURFACE THAT WORKS WITH OR WITHOUT CHALK, WOOD RINGS HAVE A DISTINCT, NATURAL FEEL PREFERRED BY MANY ATHLETES. THE WOOD GYM RINGS ARE ALSO DESIGNED AND MADE FOR LASTING DURABILITY AND COMFORT.

RING DIAMETER: 23.5CM; MAX WEIGHT SUPPORT: 500KG; EACH STRAP IS 6 METER LONG

PACKAGE SIZE: 28CM X 26CM X 8CM // PACKAGE WEIGHT: 1KG

SKU GR-1100-NL



CANNON BALL IN PAIR

LEVEL UP YOUR NINJA WARRIOR AND SPARTAN RACE TRAINING WITH YOUR OWN SET OF CANNON BALL IN PAIR / GRAVITY GRIPS.

WHETHER YOU ARE EXPERIENCED IN PARKOUR, A CLIMBING ENTHUSIAST OR JUST LOOKING TO TAKE YOUR NINJA TRAINING TO THE NEXT LEVEL, THESE SUSPENSION HOLDS WILL HELP YOU DEVELOP ULTIMATE GRIP STRENGTH LIKE NOTHING ELSE. GRAVITY GRIPS ARE THE PERFECT ADDITION TO EXPAND YOUR HOME GYM, CLIMBING CENTRE, URBAN GYM OR STREET WORKOUT SPACE.

PACKAGE SIZE: 20CM X 20CM X 10CM // PACKAGE WEIGHT: 1.8KG

SKU PG-1003-NL

FUNCTIONAL TRAINING



TRX WALL MOUNTAIN ANCHOR

THE TRX X-MOUNT IS A SECURE ANCHORING POINT FOR THE TRX SUSPENSION TRAINER. THE X-MOUNT ATTACHES EASILY TO WALLS, VERTICAL STUDS, AND OVERHEAD BEAMS. IT CAN BE USED IN CONJUNCTION WITH THE TRX SUSPENSION TRAINER AND ALSO BE USED TO HANG PUNCHING BAG ETC. THE 4.5-INCH DIAMETER PLATE IS MADE OF RUGGED STEEL.

 PACKAGE SIZE: 15CM X 5CM X 10CM // PACKAGE WEIGHT: 1KG

SKU TR-2002-NL



SUSPENSION TRAINER TRX

HEAVY DUTY WEBBING WITH FOAM COVERED HANDLES PLUS WEBBING FOOT LOOPS. STRAPS ADJUSTABLE FROM 110CM TO 145CM (TOTAL LENGTH FROM "D" CLIP TO END OF FOOT LOOP). 95CM ANCHOR STRAP WITH SNAPLOCK HOOKS ENDS. DOOR ANCHOR STRAP

 PACKAGE SIZE: 20CM L X 12CM W X 17CM H, WEIGHT: 1.5KG

SKU TR-2001-NL



CROSSFIT PARALLETTE

THE CROSSFIT HIGH PARALLETTE IS A SIMPLE, PORTABLE, YET MULTI-PURPOSE AND VERSATILE PIECE OF STRENGTH TRAINING EQUIPMENT THAT WORKS ARMS, CHEST, BACK AND CORE MUSCLES LIKE NO OTHER CAN, USING YOUR OWN BODY WEIGHT AS RESISTANCE.

SIZE: 72CML X 43CMW X 80CMH
PACKING: 1 PAIR OF PARALLETTE PACKED IN A CARTON

 PACKAGE SIZE: 75CM L X 75CM W X 18CM H, WEIGHT: 14.5 KG

SKU AP-9002-NY



TRAINING PARALLETTE

OUR TRAIN PARALLETTE IS DESIGNED FOR BODY WEIGHT EXERCISES THAT ARE SIMILAR TO PARALLEL BARS IN GYMNASICS. THEY ARE CONSTRUCTED FROM DURABLE HIGH QUALITY STEEL. SECURELY SUPPORT AND BALANCE BODY WEIGHT WITHOUT MOVING OR TIPPING. IDEAL FOR LEVERAGE-BASED WORKOUTS — PUSHUPS, DIPS AND V-SITS

SIZE: 64CML X 35.5CMW X 33CMH
PACKING: 1 PAIR OF PARALLETTE PACKED IN A CARTON

 PACKAGE SIZE: 33CM L X 67CM W X 13CM H, WEIGHT: 11.5KG

SKU AP-9001-NY



MULTI-FUNCTION RESISTANCE TRAINING STICK

RESISTANCE TRAINING STICK EMPLOYS AN INNOVATIVE RESISTANCE CORD SYSTEM TO CREATE A VARIABLE, UNBALANCED LOAD THAT ENABLES YOU TO DEVELOP CORE STRENGTH, EXPLOSIVE POWER, FLEXIBILITY AND ENDURANCE. THE RESISTANCE TRAINING STICK IS EASILY PORTABLE AND USED TO INCREASE THE ROTATIONAL BODY STRENGTH, EXPLOSIVE POWER, CORE STABILITY AND FUNCTIONAL TRAINING.

 PACKAGE SIZE: 57.5CM X 8CM X 9CM // PACKAGE WEIGHT: 2.5KG

SKU JF-JC004B



BOXING TRAINING SET

LIGHT WEIGHT BUT POWERFUL: FABRIC PROTECTOR AND STRONG LATEX TUBE. SOFT PADS FOR COMFORT AND SAFETY USE. FOR BOXING, BASKETBALL, VOLLEYBALL AND FOOTBALL SPORTS TRAINING. ALSO FOR THOSE PEOPLE WHO HAVE SPECIAL RESISTANCE TRAINING NEEDS THAT INVOLVE ARMS, LEGS, AND LOWER BACK.

 PACKAGE SIZE: 30CM X 20CM X 10CM // PACKAGE WEIGHT: 1KG

SKU JF-JR021

FUNCTIONAL TRAINING



WOODEN SLANT BOARD

- MAKES YOUR MUSCLES MORE RESPONSIVE DURING EXERCISE
- HELPS REDUCE LEG FATIGUE IMPROVES POSTURE WHILE SITTING AT WORK
- HELPS YOU STRETCH TO PROPERLY AND REDUCE THE CHANCE OF INJURY
- INCREASES YOUR FLEXIBILITY, BALANCE AND STRENGTH, IMPROVE POSTURE
- HELPFUL IN REHABILITATION OF ACHILLES TENDON INJURIES, SHIN SPLINTS, CALF STRAINS AND OTHER FOOT/LEG/ANKLE PAIN ISSU
- FIVE ADJUSTABLE POSITION IN INCREASING ANGLES FOR A PROGRESSIVE MUSCLE STRETCH THERAPY.

 **PACKAGE SIZE: 40CM X 30CM X 25CM // PACKAGE WEIGHT: 3KG**

SKU SB-1001-NL

PLYOMETRIC BOXES



30CM PLYOMETRIC BOX

PLYOMETRIC BOX IS EXTREMELY POPULAR WITH CROSSFIT ATHLETICS. HEAVY DUTY WELDED STEEL CONSTRUCTION, POWDER COATED BLACK FOR LONG LASTING DURABILITY.
SIZE: 43CM L X 43CM W X 32CM H

PACKAGE SIZE: 43CM L X 43CM W X 32CM H, WEIGHT: 5KG

SKU GB-1030-NL



75CM PLYOMETRIC BOX

PLYOMETRIC BOX IS EXTREMELY POPULAR WITH CROSSFIT ATHLETICS. HEAVY DUTY WELDED STEEL CONSTRUCTION, POWDER COATED BLACK FOR LONG LASTING DURABILITY.
SIZE: 66CM L X 66CM W X 73CM H

PACKAGE SIZE: 66CM L X 66CM W X 73CM H, WEIGHT: 10KG

SKU GB-1075-NL



45CM PLYOMETRIC BOX

PLYOMETRIC BOX IS EXTREMELY POPULAR WITH CROSSFIT ATHLETICS. HEAVY DUTY WELDED STEEL CONSTRUCTION, POWDER COATED BLACK FOR LONG LASTING DURABILITY.
SIZE: 51CM L X 51CM W X 47CM H

PACKAGE SIZE: 51CM L X 51CM W X 47CM H, WEIGHT: 6KG

SKU GB-1045-NL



SET OF PLYOMETRIC BOX, INCL 4 BOXES

SET OF PLYOMETRIC BOX (INCL 4 BOXES)
INCLUDING 30CM, 45CM, 60CM AND 75CM PLYO BOXES
EACH IN PLASTIC WRAP

PACKAGE SIZE: 66CM L X 66CM W X 73CM H, WEIGHT: 30KG

SKU GB-1100-NL



60CM PLYOMETRIC BOX

PLYOMETRIC BOX IS EXTREMELY POPULAR WITH CROSSFIT ATHLETICS. HEAVY DUTY WELDED STEEL CONSTRUCTION, POWDER COATED BLACK FOR LONG LASTING DURABILITY.
SIZE: 59CM L X 59CM W X 62CM H

PACKAGE SIZE: 59CM L X 59CM W X 62CM H, WEIGHT: 8KG

SKU GB-1060-NL



WOODEN PLYO BOX

THE WOODEN 3-IN-1 PLYOMETRIC BOX IS A STAPLE ITEM OF ANY FITNESS STUDIO OR CROSSFIT BOX. THIS ITEM IS CNC MACHINE CUT WITH ROUNDED EDGES AND PRE DRILLED SCRES.
SIZE: 76CM/61CM/51CM

PACKAGE SIZE: 77CM L X 50CM W X 23CM H, WEIGHT: 22KG

SKU GB-1200-NL

PLYOMETRIC BOXES



3 IN 1 FOAM PLYOMETRIC BOX

THE 3-IN-1 FOAM SOFT PLYO BOXES COMBINE SAFETY AND CONVENIENCE WITH EASY TO READ HEIGHT MEASUREMENTS AND FIRM FOAM MATERIAL. EACH SIDE IS COLOR-CODED ACCORDING TO THE THREE HEIGHTS FOR EACH BOX. ATHLETES CAN PERFORM BOX JUMPS WITHOUT FEAR OF SCRAPING THEIR SHINS AND STILL HAVE THE SECURITY THAT THE BOX WILL STAY IN PLACE.

THREE SIZES ARE: 20 INCH; 24 INCH; 30 INCH

 PACKAGE SIZE: 51CM L X 61CM W X 75CM H, WEIGHT: 35KG

SKU GB-1310-NL



MINI 3 IN 1 FOAM PLYOMETRIC BOX

THE MINI 3-IN-1 FOAM SOFT PLYO BOXES COMBINE SAFETY AND CONVENIENCE WITH EASY TO READ HEIGHT MEASUREMENTS AND FIRM FOAM MATERIAL. EACH SIDE IS COLOR-CODED ACCORDING TO THE THREE HEIGHTS FOR EACH BOX. ATHLETES CAN PERFORM BOX JUMPS WITHOUT FEAR OF SCRAPING THEIR SHINS AND STILL HAVE THE SECURITY THAT THE BOX WILL STAY IN PLACE.

THREE SIZES ARE: 16 INCH; 14 INCH; 12 INCH

 PACKAGE SIZE: 40CM L X 35CM W X 30CM H, WEIGHT: 15KG

SKU GB-1320-NL



FOAM PLYOMETRIC BOX SET

THE PLYOSOFT BOX SET IS DESIGNED TO BE SAFE, AND TO GIVE USERS CONFIDENCE WHEN PERFORMING PLYOMETRIC TRAINING. ITS SOFT DESIGN MINIMISES THE RISK OF INJURY, AND STRONG VELCRO FIXING STRAPS KEEP BOXES LOCKED IN PLACE. PLYOMETRIC TRAINING SHOULD BE PERFORMED ON APPROPRIATE FLOORING TO ABSORB SOME OF THE IMPACT OF THE EXERCISES ON MEMBERS' JOINTS.

 PACKING: 1PC IN 1 BOX, TOTAL 4 BOXES. SIZE: H60/H45/H30/H15 X W55 X L55CM

SKU GB-1300-NL

POWER SLED



COMPACT SLED WITH HARNESS

COMPACT SLED IS A PORTABLE OPTION FOR ALL YOUR CONDITIONING AND AGILITY NEEDS. SUITABLE FOR USE ON ALL SURFACES AND WITH BENT SIDES TO ALLOW EASY REMOVAL OF WEIGHT PLATES FROM THE STACKER, THE DESIGN IS FLAWLESS WITH ITS PRACTICALITY.

UNIT SIZE FOLDED: 61CM L X 42CM W X 8CM H

UNIT SIZE UPRIGHT: 61CM L X 42CM W X 46CM H

 PACKAGE SIZE: 62CM L X 45CM W X 8CM H, WEIGHT: 16KG

SKU AS-8008-NL



WEIGHT RESISTOR SAC

FEATURES INCLUDES 6 DURABLE WEIGHT SAND BAGS THAT CAN BE FILLED WITH UP TO 30KG SAND
SLED MATERIAL WON'T HARM GRASS OR MARK WOOD FLOORS
ADJUSTABLE LEASH LENGTH TO ACCOMMODATE ATHLETES OF ANY SIZE
DURABLE TOWING BELT COMES WITH 190CM QUALITY PULLING ROPE.
SAND NOT INCLUDED
SIZE: 70CM X 32CM

 PACKAGE SIZE: 35CM X 32.5CM X 12.5CM // PACKAGE WEIGHT: 3.5KG

SKU AS-8006-NL



DOG SLED / MULTI-FUNCTIONAL SLED

IDEAL FOR CROSS TRAINING. BUILD TOUGH FOR PUSH, PULL AND EXPLOSIVE TRAINING ON VARIABLE SURFACES. USED BY ATHLETES, SPORTS CLUB AND PERFORMANCE CENTRES.

SIZE: 115CM X 64CM X 110CM H;

 PACKAGE SIZE: 115CM L X 64CM W X 40CM H, WEIGHT: 30KG

SKU AS-8007-NY



SINGLE SIDE POWER SLED WITH HARNESS

SLED HELPS TO DEVELOP GREAT STRENGTH AND ENDURANCE. IT IS GREAT FOR UNSTOPPABLE RUNNING POWER. JUST PUT REGULAR WEIGHT PLATES ON SLED, STRAP ON HARNESS AND SEE HOW FAR YOU CAN RUN.

SLED HARNESS IS INCLUDED.

SIZE: 84L X 43W X 24H

 PACKAGE SIZE: 65CM L X 36CM W X 12 CM H WEIGHT: 6KG

SKU AS-8001-NL



PROWLER SLED

PLATE STORAGE STATIONS ALLOW FOR OVERLOAD STRENGTH TRAINING WHILE KEEPING SLED EVENLY BALANCED.

MULTI POINT ATTACHMENTS ALLOW FOR EVEN LOAD DURING PULLING EXERCISES.

ALL TYPES OF SLED DRAGGING OR PUSHING

BUILDING LOWER AND UPPER BODY STRENGTH AND ENDURANCE

JUST ADD YOUR OLYMPIC PLATES TO ACHIEVE YOUR DESIRED RESISTANCE.

SIZE: 100CM X 91CM X 105CM

 PACKAGE SIZE: 100CM L X 40CM W X 60CM H, WEIGHT: 25KG

SKU AS-8005-NL

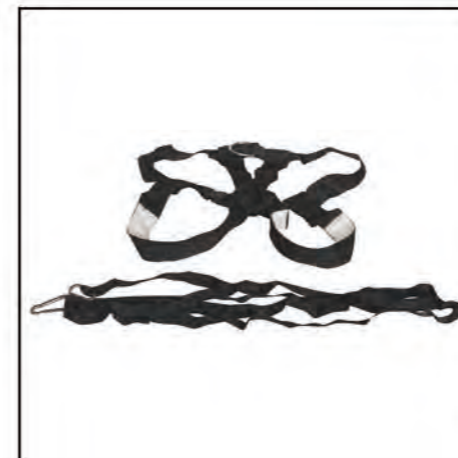

SLED HARNESS

SLED HARNESS

1 IN A CLOTH BAG

 PACKAGE SIZE: 20CM X 20CM X 10CM // WEIGHT: 0.8KG

SKU AS-8003-NL

POWER WEIGHTED & BULGARIAN BAG

SHUTRADING
AUSTRALIA BEST FITNESS SUPPLIER



5KG POWER WEIGHTED BAG

WEIGHTED BAG IS A TOTALLY FUNCTIONAL 'USE ANYWHERE' SOFT TO TOUCH WEIGHT SYSTEM. ALL WEIGHT BAGS ARE FOAM LINED AND COVERED WITH HEAVY DUTY VINYL FOR MAXIMUM DURABILITY AND SAFETY. ALL BAGS ARE FILLED WITH SAND.
SIZE: 54CM X 23CM X 23CM

 PACKAGE SIZE: 57CM X 27CM X 27CM // PACKAGE WEIGHT: 6KG

SKU WB-1050-NL



20KG POWER WEIGHTED BAG

WEIGHTED BAG IS A TOTALLY FUNCTIONAL 'USE ANYWHERE' SOFT TO TOUCH WEIGHT SYSTEM. ALL WEIGHT BAGS ARE FOAM LINED AND COVERED WITH HEAVY DUTY VINYL FOR MAXIMUM DURABILITY AND SAFETY. ALL BAGS ARE FILLED WITH SAND.
SIZE: 58CM X 23CM X 23CM

 PACKAGE SIZE: 60CM X 27CM X 27CM // PACKAGE WEIGHT: 21KG

SKU WB-1200-NL



10KG POWER WEIGHTED BAG

WEIGHTED BAG IS A TOTALLY FUNCTIONAL 'USE ANYWHERE' SOFT TO TOUCH WEIGHT SYSTEM. ALL WEIGHT BAGS ARE FOAM LINED AND COVERED WITH HEAVY DUTY VINYL FOR MAXIMUM DURABILITY AND SAFETY. ALL BAGS ARE FILLED WITH SAND.
SIZE: 54CM X 23CM X 23CM

 PACKAGE SIZE: 57CM X 27CM X 27CM // PACKAGE WEIGHT: 11KG

SKU WB-1100-NL



BULGARIAN BAG

THE BULGARIAN BAG WAS A TRAINING TOOL THAT WOULD ALLOW HIS WRESTLERS TO IMPROVE EXPLOSIVE DYNAMIC MOVEMENTS IN PUSHING, TWISTING, SWINGING, ROTATING, SQUATTING, LUNGING, THROWING AND LUNGING.

5KG WB-3050-NL // PACKAGE SIZE: 75CM X 25CM X 22CM // WEIGHT: 5KG
10KG WB-3100-NL // PACKAGE SIZE: 75CM X 25CM X 22CM // WEIGHT: 10KG
15KG WB-3150-NL // PACKAGE SIZE: 75CM X 25CM X 22CM // WEIGHT: 15KG
20KG WB-3200-NL // PACKAGE SIZE: 75CM X 25CM X 22CM // WEIGHT: 20KG



15KG POWER WEIGHTED BAG

WEIGHTED BAG IS A TOTALLY FUNCTIONAL 'USE ANYWHERE' SOFT TO TOUCH WEIGHT SYSTEM. ALL WEIGHT BAGS ARE FOAM LINED AND COVERED WITH HEAVY DUTY VINYL FOR MAXIMUM DURABILITY AND SAFETY. ALL BAGS ARE FILLED WITH SAND.
SIZE: 54CM X 23CM X 23CM

 PACKAGE SIZE: 57CM X 27CM X 27CM // PACKAGE WEIGHT: 16KG

SKU WB-1150-NL



30KG EMPTY CROSSFIT SAND POWER BAG

STRONG AND RELIABLE DESIGN WITH EASY GRIP THICK HANDLES FOR MAXIMUM SUPPORT, CARRY HANDLES ON BOTH TOP, BOTTOM AND ON BOTH ENDS. SPECIAL INNER BAGS TO HOLD THE SAND SO IT DOES NOT LEAK, RECOMMEND FILL WITH FULL INNER SAND BAGS WITH STRONG EASY FILL ZIP CLOSURES

 PACKAGE SIZE: 60CM X 33CM X 33CM // PACKAGE WEIGHT: 1KG

SKU WB-2030-NL

IF YOU HAVE ANY QUESTIONS OR WOULD LIKE SOME VALUABLE ADVICE, PLEASE FEEL FREE TO CONTACT US.

WWW.SHUTRADE.COM.AU

WEIGHT VEST



30KG WEIGHT VEST FOR MEN

THIS SET INCLUDES A MEN'S WEIGHT VEST AND 30KG BLOCKS. THE WEIGHTED VEST IS A VERY GOOD TOOL FOR USE IN ALL TYPES OF SPORT OR FITNESS TRAINING. THIS MEN'S VEST CONTAINS 30 INDIVIDUAL WEIGHT SACHETS TO HOLD FROM 1KG TO 30KG BLOCKS. YOU MAY ADJUST THE WEIGHT LEVEL AND REMOVE OR TRANSFER THE WEIGHTS FROM THE PACKETS. THE BLOCKS ARE PACKED SEPARATELY.

PACKAGE SIZE: 45CM X 33CM X 8CM // PACKAGE WEIGHT: 31.5KG

30KG AV-1300-HC



WEIGHT VEST FOR MEN (VEST ONLY)

MADE OF HEAVY DUTY REINFORCED NYLON. FEATURING DOUBLE PADDED SHOUDLERS FOR ADDED COMFORT. ADJUSTABLE STRAP AND VELCRO CLOSURES CONTAIN 30 INDIVIDUAL WEIGHT SACHETS TO HOLD FROM 1KG TO 30KG BLOCKS. 15 POCKETS IN THE FRONT AND 15 POCKETS AT THE BACK

PACKAGE SIZE: 45CM X 33CM X 8CM // PACKAGE WEIGHT: 1.5KG

SKU AV-1030-HC



10KG WEIGHT VEST FOR LADIES

THIS SET INCLUDES A LADIES WEIGHT VEST AND 10KG BLOCKS. THE WEIGHTED VEST IS A VERY GOOD TOOL FOR USE IN ALL TYPES OF SPORT OR FITNESS TRAINING. THIS LADIES VEST CONTAINS 10 INDIVIDUAL WEIGHT SACHETS TO HOLD FROM 1KG TO 10KG BLOCKS. YOU MAY ADJUST THE WEIGHT LEVEL AND REMOVE OR TRANSFER THE WEIGHTS FROM THE PACKETS. THE BLOCKS ARE PACKED SEPARATELY.

PACKAGE SIZE: 45CM X 33CM X 8CM // PACKAGE WEIGHT: 11.5KG

10KG AV-2100-HC



WEIGHT VEST FOR LADIES (VEST ONLY)

MADE OF HEAVY DUTY REINFORCED NYLON. FEATURING DOUBLE PADDED SHOUDLERS FOR ADDED COMFORT. ADJUSTABLE STRAP AND VELCRO CLOSURES CONTAINS 10 INDIVIDUAL WEIGHT SACHETS TO HOLD FROM 1KG TO 10KG BLOCKS. 3 POCKETS IN THE FRONT AND 7 POCKETS AT THE BACK

PACKAGE SIZE: 45CM X 33CM X 8CM // PACKAGE WEIGHT: 1.5KG

SKU AV-2010-HC



WEIGHT BLOCK

MADE BY SOLID CAST IRON WITH 2 DIFFERENT WEIGHT 1KG/PC AND 0.5KG/PC POWER COATED WITH BLACK.

SIZE: 1KG - 9CM X 5CM X 3CM

0.5KG - 4.5CM X 5CM X 3CM

PACKAGE SIZE: 1KG - 10PC/CARTON 20CM X 10CM X 10CM
PACKAGE SIZE: 0.5KG - 30PC/CARTON 20CM X 10CM X 10CM

1KG AV-3010-NL **0.5KG** AV-3005-NL

ANKLE WEIGHT



2KG ADJ. ANKLE WEIGHTS, BLOCK

2KG ADJ. ANKLE WEIGHTS IN SOLID CASTLE IRON STICK
ADJUSTABLE IN 100GM INCREMENTS UP TO A TOTAL OF 1KG PER LEG AND
2KG IN A PAIR
(20 X 0.1KG INCREMENTS). SIZE: 26CM X 10.5CM X 1.5CM
1PC IN A PLASTIC BAG; A PAIR IN A COLOR PAPER CARTON

PACKAGE SIZE: 14CM X 14CM X 9 CM // PACKAGE WEIGHT: 2KG

2KG AV-4020-HC



5KG ADJ. ANKLE WEIGHTS, SACHEL

5KG ADJ. ANKLE WEIGHTS IN SOFT SACHEL
ADJUSTABLE IN 500GM INCREMENTS UP TO A TOTAL OF 2.5KG PER LEG AND 5KG
IN A PAIR
(10 X 0.5KG INCREMENTS). SIZE: 36CM X 15CM X 3.5CM
1PC IN A PLASTIC BAG; A PAIR IN A COLOR PAPER CARTON

PACKAGE SIZE: 20CM X 15CM X 11.5 CM // PACKAGE WEIGHT: 5KG

5KG AV-5050-HC



4KG ADJ. ANKLE WEIGHTS, BLOCK

4KG ADJ. ANKLE WEIGHTS IN SOLID CASTLE IRON STICK
ADJUSTABLE IN 400GM INCREMENTS UP TO A TOTAL OF 2KG PER LEG AND
4KG IN A PAIR
(10 X 0.4KG INCREMENTS). SIZE: 35CM X 17CM X 2CM
1PC IN A PLASTIC BAG; A PAIR IN A COLOR PAPER CARTON

PACKAGE SIZE: 35CM X 17CM X 2CM // PACKAGE WEIGHT: 4KG

4KG AV-4040-HC



10KG ADJ. ANKLE WEIGHTS, SACHEL

10KG ADJ. ANKLE WEIGHTS IN SOFT SACHEL
ADJUSTABLE IN 1KG INCREMENTS UP TO A TOTAL OF 5KG PER LEG AND 10KG
IN A PAIR
(10 X 1.0KG INCREMENTS). SIZE: 36CM X 15CM X 3.5CM
1PC IN A PLASTIC BAG; A PAIR IN A COLOR PAPER CARTON

PACKAGE SIZE: 22CM X 17.5CM X 16 CM // PACKAGE WEIGHT: 10KG

10KG AV-5100-HC



FIXED SOFT ANKLE WEIGHTS 1KG/2KG

THE ANKLE WRAP WEIGHTS ARE IDEAL FOR INCREASING CALORIE BURN DURING
LOWER BODY ACTIVITIES.
BUILD STRENGTH, SLIM HIPS AND TONE LEGS
SECURE EASY-GRIP CLOSURE
1KG: EACH ANKLE IS 0.5KG
2KG: EACH ANKLE IS 1KG

PACKAGE SIZE: 27CM X 5CM X 10CM // PACKAGE WEIGHT: 1KG
PACKAGE SIZE: 27CM X 5CM X 10CM // PACKAGE WEIGHT: 2KG

1KG AV-5010-HC 2KG AV-5020-HC



FIXED SOFT ANKLE WEIGHTS 3KG/4KG

THE ANKLE WRAP WEIGHTS ARE IDEAL FOR INCREASING CALORIE BURN DURING
LOWER BODY ACTIVITIES.
BUILD STRENGTH, SLIM HIPS AND TONE LEGS
SECURE EASY-GRIP CLOSURE
3KG: EACH ANKLE IS 1.5KG
4KG: EACH ANKLE IS 2KG

PACKAGE SIZE: 30CM X 6CM X 11CM // PACKAGE WEIGHT: 3KG
PACKAGE SIZE: 30CM X 6CM X 11CM // PACKAGE WEIGHT: 4KG

3KG AV-5030-HC 4KG AV-5040-HC

RESISTANCE POWER BAND

RESISTANCE RUBBER BAND

MADE OF TOP QUALITY LATEX RUBBER, GOOD ELASTIC, GREAT FOR FLEXIBILITY AND STRENGTH TRAINING SUCH AS CROSSFIT, PULL UPS, POWER LIFTING, STRETCHING ,CROSSFIT WORKOUT ,PILATES YOGA, BOXING AND OTHER FITNESS EXERCISES.TOTAL LENGTH 200 CM X WIDTH 12 MM RESISTANCE: 20-35 LB RED COLOR 1PC IN A PLASTIC BAG.

PACKAGE SIZE: 28CM X 10CM X 5CM // PACKAGE WEIGHT: 0.2KG

LOOP BANDS / SHORTY MONSTER BANDS

RESISTANCE BAND, USED TO EXERCISE THE MUSCLES OF THE HIPS AND LEGS AS WELL AS WRISTS AND ARMS WHICH HELPS TO INCREASE MUSCLE TONE AND STRENGTH, CLOSED-LOOP DESIGN, GOOD TO KEEP BALANCE AND COORDINATION. FLAT BAND FITS COMFORTABLY AROUND UPPER OR LOWER LEGS. TEXTURED SURFACE FOR PROFESSIONAL GYM USE. PERFECT FOR ASSISTED PULL-UPS, AEROBICS, YOGA AT HOME OR GYM. CONVENIENT TO EXERCISE AT ANY TIME AND ANY PLACE. GOOD ELASTICITY AND DURABLE AND LIGHT WEIGHT AND PORTABLE

PACKAGE SIZE: 28CM X 10CM X 5CM // PACKAGE WEIGHT: 0.2KG



12MM RESISTANCE RUBBER BAND

SKU AB-4012-NL



19MM RESISTANCE RUBBER BAND

SKU AB-4019-NL



28MM RESISTANCE RUBBER BAND

SKU AB-4028-NL



SHORTY MONSTER BANDS 15-25LB

SKU AB-4301-HC



SHORTY MONSTER BANDS 20-40LB

SKU AB-4302-HC



SHORTY MONSTER BANDS 30-60LB

SKU AB-4303-HC



44MM RESISTANCE RUBBER BAND

SKU AB-4044-NL



64MM RESISTANCE RUBBER BAND

SKU AB-4044-NL



CHROME RESISTANCE BAND HANDLE

SKU AB-4200-NL



SHORTY MONSTER BANDS 40-80LB

SKU AB-4304-HC



SHORTY MONSTER BANDS 50-100LB

SKU AB-4305-HC



SHORTY MONSTER BANDS SET

SKU AB-4300-HC

IF YOU HAVE ANY QUESTIONS OR WOULD LIKE SOME VALUABLE ADVICE, PLEASE FEEL FREE TO CONTACT US.

WWW.SHUTRADE.COM.AU

RESISTANCE POWER BAND

FABRIC RESISTANCE BOOTY BAND (INCL. 5PCS) **SKU** AB-4700-NL

THESE EXERCISE BANDS COME WITH DIFFERENT LEVELS OF RESISTANCE. IT INCLUDES THE YELLOW (X-LIGHT-13", 5-10LBS), GREEN (LIGHT-13", 10-15LBS), BLUE (MEDIUM-13", 15-20LBS), ORANGE (HEAVY-13", 25-30LBS) AND BLACK (X-LARGE-13", 30-40LBS). EACH BAND HAS A DIFFERENT RESISTANCE LEVEL. THIS ALLOWS ATHLETES TO FIND THE PROPER LEVEL OF RESISTANCE THAT IS COMFORTABLE AND MOST BENEFICIAL TO THE SPECIFIC MOVEMENT DESIRED. PACKAGE SIZE: 15CM X 115CM X 5CM // PACKAGE WEIGHT: 0.3KG



FABRIC RESISTANCE LONG BAND **SKU** AB-4800-NL

RESISTANCE BAND, USED TO EXERCISE THE MUSCLES OF THE HIPS AND LEGS AS WELL AS WRISTS AND ARMS WHICH HELPS TO INCREASE MUSCLE TONE AND STRENGTH, CLOSED-LOOP DESIGN, GOOD TO KEEP BALANCE AND COORDINATION. FLAT BAND FITS COMFORTABLY AROUND UPPER OR LOWER LEGS. TEXTURED SURFACE FOR PROFESSIONAL GYM USE. PERFECT FOR ASSISTED PULL-UPS, AEROBICS, YOGA AT HOME OR GYM. CONVENIENT TO EXERCISE AT ANY TIME AND ANY PLACE. GOOD ELASTICITY AND DURABLE AND LIGHT WEIGHT AND PORTABLE. PACKAGE SIZE: 28CM X 10CM X 5CM // PACKAGE WEIGHT: 0.2KG

15-25LB

SKU AB-4301-HC

20-40LB

SKU AB-4302-HC

30-60LB

SKU AB-4303-HC

40-80LB

SKU AB-4304-HC

50-100LB

SKU AB-4305-HC

SET

SKU AB-4300-HC

◀ IF YOU HAVE ANY QUESTIONS OR WOULD LIKE SOME VALUABLE ADVICE, PLEASE FEEL FREE TO CONTACT US.

WWW.SHUTRADE.COM.AU

GYM FLOORING MAT

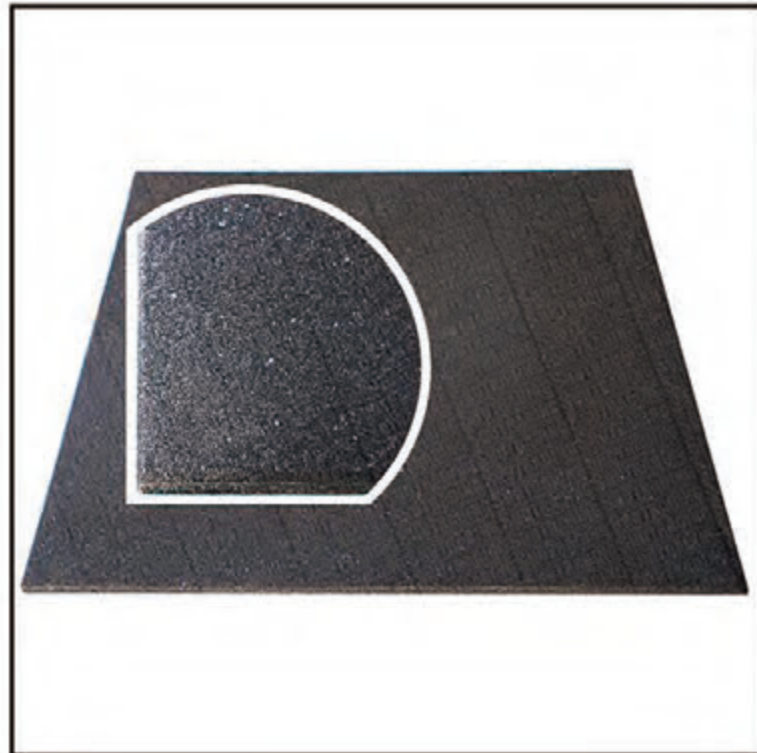

RUBBER FLOOR MAT WITH BLUE FLECKS

- RUBBER TILES, BLACK WITH BLUE FLECKS // 15MM THICKNESS
- STANDARD 1M X 1M X 15MM SIZE WITH BEVELED EDGE
- EASY INSTALLATION – SIMPLY LAY EACH RUBBER TILE ON A FLAT SURFACE, NO NEED FOR ANY NASTY GLUES OR ADHESIVES
- SHOCK-ABSORBANT – IDEAL FOR HIGH IMPACT USES
- EACH RUBBER TILE WEIGHS ABOUT 12KG
- MADE FROM PREMIUM 100% RECYCLED TYRE RUBBER
- REDUCES NOISE AND VIBRATIONS // EASY CLEANING WITH A BROOM OR SPONGE INDOOR
- EASILY CUT TO FIT INTO CORNERS WITH A STANLEY KNIFE



PACKAGE SIZE: 1M X 1M X 15MM // PACKAGE WEIGHT: 12KG // THICKNESS: 15MM

SKU

AM-1002-NL

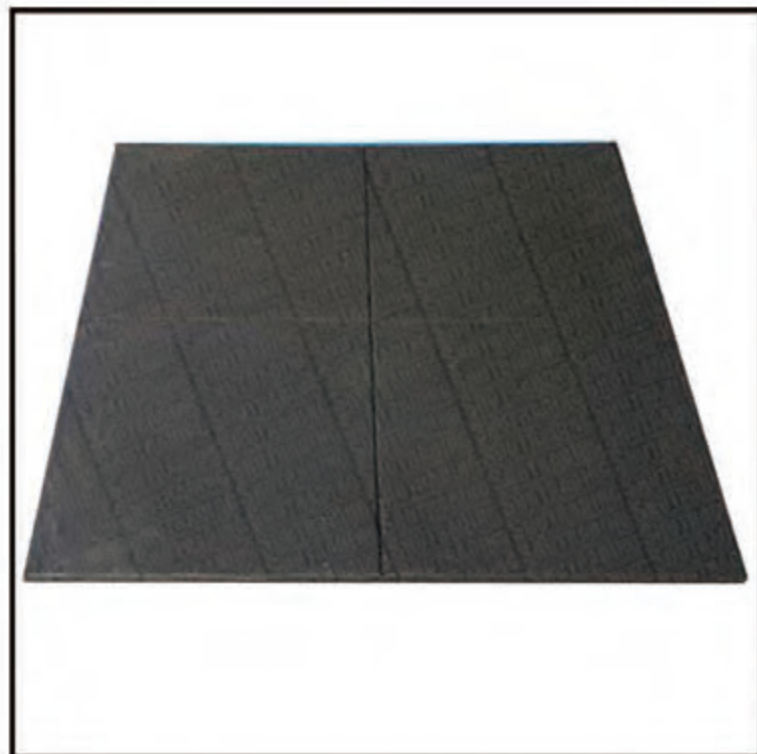

BLACK RUBBER TILES

- 15MM THICKNESS
- STANDARD 1M X 1M X 15MM SIZE WITH BEVELED EDGE
- EASY INSTALLATION – SIMPLY LAY EACH RUBBER TILE ON A FLAT SURFACE, NO NEED FOR ANY NASTY GLUES OR ADHESIVES
- SHOCK-ABSORBANT – IDEAL FOR HIGH IMPACT USES
- EACH RUBBER TILE WEIGHS ABOUT 12KG
- MADE FROM PREMIUM 100% RECYCLED TYRE RUBBER
- REDUCES NOISE AND VIBRATIONS
- EASY CLEANING WITH A BROOM OR SPONGE INDOOR
- EASILY CUT TO FIT INTO CORNERS WITH A STANLEY KNIFE



PACKAGE SIZE: 1M X 1M X 15MM // PACKAGE WEIGHT: 12KG // THICKNESS: 15MM

SKU

AM-1001-NL

YOGA BALANCE



COMMERCIAL GYM BALL / SWISS BALL

TRAINING WITH EXERCISE BALLS HELPS IMPROVE BALANCE, COORDINATION, FLEXIBILITY AND ARE IDEAL FOR CORE STRENGTH EXERCISES. TRAINING, TONING, RESISTANCE EXERCISES AND MUCH MORE. OUR COMMERCIAL GYM BALLS ARE DESIGNED FOR USE IN COMMERCIAL GYMS, AND ARE ALSO IDEAL FOR HOME USE. THESE COMMERCIAL FITNESS BALLS HAVE BEEN WEIGHT-RATED UP TO 2000 POUNDS (STATIC WEIGHT CAPACITY). SIZE AVAILABLE: 55CM, 65CM, 75CM, 85CM

PACK SIZE: 26CM X 23CM X 13CM (WEIGHT: 1.5KG/ 1.65KG/ 1.85KG/ 2KG)

55CM GA-3055-HC 65CM GA-3065-HC
75CM GA-3075-HC 85CM GA-3085-HC



STANDARD GYM BALL WITH PUMP

STANDARD SWISS BALLS ARE A FANTASTIC WORKOUT TOOL THAT CAN BE USE TO WORK NEARLY EVERY MUSCLE IN YOUR BODY. NEARLY EVERY EXERCISE YOU CAN THINK OF CAN BE DONE ON A SWISS BALL TURNING YOUR SWISS BALL INTO A MOBILE GYM.

SIZE: 55CM / 65CM / 75CM

PACK SIZE: 25CM X 14CM X 18CM (WEIGHT: 1.0KG/ 1.40KG/ 1.70KG)

55CM GA-1055-HC 65CM GA-1065-HC
75CM GA-1075-HC

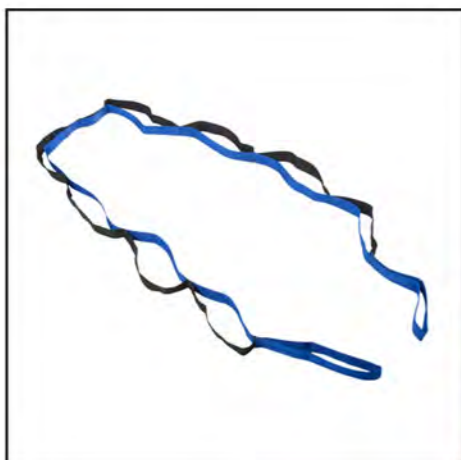

YOGA STRETCH STRAP

THE STRAP THAT STRETCHES AS YOU STRETCH. THE STRETCH STRAP IS MADE WITH ELASTIC POCKETS THAT ALLOW THE USER TO EASE INTO A STRETCH. STRETCH STRAP PERMITS DYNAMIC RATHER THAN STATIC STRETCHING.

SIZE: LENGTH 182CM

PACKAGE SIZE: 10CM X 10CM X 3CM // PACKAGE WEIGHT: 0.3KG

SKU EA-9006-HC



NEW BOSU STYLE BALANCE BALL

THE BOSU BALL IS ANOTHER PIECE OF SPORTS EQUIPMENT THAT IS USED TO IMPROVE MARTIAL ARTS BALANCE SKILLS. THE BOSU BALL IS A FLEXIBLE RUBBER HEMISPHERE ATTACHED TO A HARD PLASTIC BOTTOM.

SIZE: 60CM X 60CM X 30CM

PACKAGE SIZE: 60CM X 60CM X 10CM // PACKAGE WEIGHT: 6.5KG

BLUE GA-2001-NL



WOODEN BALANCE BOARD

THE 40CM WOODEN WOBBLE BOARD HAS BEEN DESIGNED AS AN AID TO HELP YOU REGAIN YOUR BALANCE AS WELL AS RESTORING YOUR STABILITY FOLLOWING AN ANKLE OR KNEE INJURY. WITH A TILT ANGLE OF 24 DEGREES, THE WOODEN WOBBLE BOARD PROVIDES AN ESSENTIAL TOOL IN THE REHABILITATION OF SPORTS INJURIES. THE WOODEN WOBBLE BOARD IS CONSTRUCTED FROM OAK WOOD AND HAS AN ANTI-SLIP PVC SURFACE TO ENSURE STABILITY WHILE USING.

MAX WEIGHT LIMIT: 120 KG

PACKAGE SIZE: 40CM X 40CM X 8CM // PACKAGE WEIGHT: 2KG

SKU AB-3002-NL



PLASTIC WOBBLE/BALANCE BOARD

ORIGINALLY DEVELOPED TO HELP SKIING AND SURFING ENTHUSIASTS IMPROVE THEIR SKILLS AT HOME, THE BALANCE OR WOBBLE BOARD HAS BECOME A POPULAR PIECE OF EQUIPMENT USED FOR ATHLETIC TRAINING, BRAIN DEVELOPMENT, PHYSIOTHERAPY AND EVEN MUSICAL THERAPY. BECAUSE WOBBLE BOARDS PROVIDE FULL ROTATION AROUND A VERTICAL AXIS, THEY EXERCISE MUSCLES THAT ARE NOT TYPICALLY USED WHILE STANDING ON BOARDS THAT ONLY TILT IN 2 (OPPOSITE) DIRECTIONS.

MAX WEIGHT LIMIT: 120 KG

PACKAGE SIZE: 40CM X 40CM X 8CM // PACKAGE WEIGHT: 1.8KG

SKU AB-3001-NL

YOGA BALANCE



EVA FOAM ROLLER

FOAM ROLLERS ARE USEFUL FOR RELIEVING ADHESIONS AND IMPROVING BALANCE. ADHESIONS ARE KNOTS IN THE MUSCLES. BY USING A FOAM ROLLER TO APPLY PRESSURE TO THE MUSCLES, IT CAN WORK OUT KNOTS JUST LIKE PRESSURE DURING A DEEP TISSUE MASSAGE. OUR EVA FOAM ROLLERS COME IN 15CM DIAMETERS AND IN 4 DIFFERENT LENGTH: 18" (45CM), 24" (60CM), 30" (75CM) AND 36" (90CM).

 PACKAGE SIZE: 15CM X 15CM X 45-90CM // PACKAGE WEIGHT: < 1KG

45CM AR-3005-NL **60CM** AR-3006-NL

75CM AR-3003-NL **90CM** AR-3004-NL



MASSAGE THERAPY 4 PIECES SET

THIS THERAPEUTIC MYOFASCIAL RELEASE BALL FEATURES SOFT SPIKES THAT SIMULATE THE REJUVENATING EFFECTS OF A SOOTHING SPORTS MASSAGE.

SMALL FOAM ROLLER: 12.5CM X 12.5CM / MASSAGE FOOT ROLLER: 17.5CM X 8.5CM

 PACKAGE SIZE: 45CM X 15CM X 24CM // PACKAGE WEIGHT: 1KG

SET MB-3000-HC



GRID RUMBLE FOAM ROLLER

FOAM ROLLERS ACT AS A SPINAL STABILIZER TO CENTRE THE BODY IN FLOOR ROUTINE. USING FOAM ROLLER WILL IMPROVE STRENGTH, BALANCE AND FLEXIBILITY. THE SURFACE OF THE RUMBLE ROLLER CONTAINS SPECIALLY DESIGNED BUMPS THAT ARE FIRM, BUT FLEXIBLE, MUCH LIKE THE THUMBS OF A MASSAGE THERAPIST.

 PACKAGE SIZE: 12.5CM X 12.5CM X 79CM, WEIGHT: 2KG (LONG)
 PACKAGE SIZE: 11CM X 11CM X 32CM, WEIGHT: 0.9KG (SHORT)

32CM AR-3008-NL **79CM** AR-3009-NL



MASSAGE THERAPY ROLLER, BLUE/PINK

IDEAL FOR ROLLING BOTH LARGE AND SMALL MUSCLE GROUPS. LONG RIDGES COMBINE WITH PRONOUNCED BUMPS TO OFFER A MORE DIVERSIFIED SURFACE AREA. THIN OUTER LAYER OF FOAM PROVIDES A FIRM SURFACE FOR AGGRESSIVE MYOFASCIAL RELEASE. BLUE COLOUR IS HARDER THAN PINK
SIZE: 47CM X 12.5CM X 12.5CM

 PACKAGE SIZE: 48CM X 15CM X 15CM // PACKAGE WEIGHT: 1.2KG

BLUE AR-3101-HC **PINK** AR-3102-HC



GRID FOAM ROLLER

CONSTRUCTED WITH LESS FOAM THAN TRADITIONAL FOAM ROLLERS. DESIGNED TO WITHSTAND CONSTANT, HEAVY, AND REPEATED USE WITHOUT BREAKING DOWN
SIZE: 15CM X 34CM

 PACKAGE SIZE: 15CM X 15CM X 34CM // PACKAGE WEIGHT: 1KG

33CM AR-3007-NL



YOGA BLOCK

300 GRAM IN NET WEIGHT, SCORING 45 OF OVERALL SUPPORTIVE HARDNESS, TOP IN THE RANGE. NON-STICK SURFACE, DURABLE EVA FOAM, HIGH DENSITY AND STUDIO QUALITY. MADE FROM DURABLE, SUPPORTIVE AND ENVIRONMENTALLY FRIENDLY EVA FOAM. ADVANCED POLISHING AND SURFACE FINISHING CRAFTSMANSHIP, FEELING GOOD TO TOUCH.

 PACKAGE SIZE: 23CM X 15CM X 8CM // PACKAGE WEIGHT: 0.3KG

SKU AB-8001-NL

YOGA BALANCE

SHUTRADING
AUSTRALIA BEST FITNESS SUPPLIER

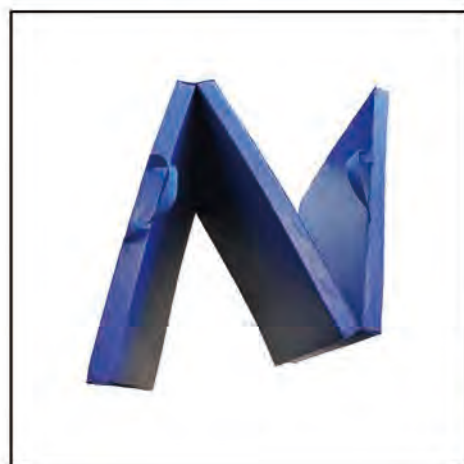

3-FOLDED VINYL GYM MAT

EXTRA THICK PADDING FOR A COMFORTABLE WORKOUT, EASY WIPE CLEAN SURFACE, FOLDS UP FOR STORAGE
TWO HANDLES FOR EASY PORTABILITY
MAT SIZE: 62CM X 62CM X 12CM

PACKAGE SIZE: 62CM X 62CM X 12CM // PACKAGE WEIGHT: 2KG

BLUE AM-3001-NL



YOGA MAT, BLUE/PINK COLOR 6MM

OUR NON-SLIP YOGA/PILATES MAT IS THE PERFECT ADDITION FOR ANY TYPE OF WORK OR STRETCHING ROUTINE, LIKE PILATES, GYMNASTICS, GENERAL FITNESS OR EVEN WII SPORTS
MAT SIZE: 173CM X 61CM X 6MM

PACKAGE SIZE: 12CM X 12CM X 62CM // PACKAGE WEIGHT: 1.18KG

BLUE AM-2001-NL **PINK** AM-2002-NL



4-FOLDED VINYL GYM MAT

EXTRA THICK PADDING FOR A COMFORTABLE WORKOUT, EASY WIPE CLEAN SURFACE, FOLDS UP FOR STORAGE
TWO HANDLES FOR EASY PORTABILITY
MAT SIZE: 45CM X 62CM X 16CM

PACKAGE SIZE: 45CM X 62CM X 16CM // PACKAGE WEIGHT: 3KG

BLACK AM-3002-NL



TPE YOGA MAT BLUE / PINK / PURPLE

OUR NON-SLIP TPE YOGA/PILATES MAT IS THE PERFECT ADDITION FOR ANY TYPE OF WORK OR STRETCHING ROUTINE, LIKE PILATES, GYMNASTICS, GENERAL FITNESS OR EVEN WII SPORTS. THE STICKY MAT PROVIDES A SOFT WORKOUT SURFACE FOR ANY ONE PLACE YOU MAY WORK OUT.
MAT SIZE: 180CM X 60CM X 6MM

PACKAGE SIZE: 15CM X 15CM X 62CM // PACKAGE WEIGHT: 1.18KG

SKU AM-2006-NL



YOGA MAT, BLUE/RED COLOR 15MM

OUR NON-SLIP YOGA/PILATES MAT IS THE PERFECT ADDITION FOR ANY TYPE OF WORK OR STRETCHING ROUTINE, LIKE PILATES, GYMNASTICS, GENERAL FITNESS OR EVEN SPORTS. THE STICKY MAT PROVIDES A SOFT WORKOUT SURFACE FOR ANY ONE PLACE YOU MAY WORK OUT.
MAT SIZE: 173CM X 61CM X 15MM

PACKAGE SIZE: 19CM X 19CM X 62CM // PACKAGE WEIGHT: 1.18KG

BLUE AM-2004-NL **RED** AM-2003-NL



PILATES RING

IDEAL FOR DEVELOPING STRENGTH AND BODY TONE.

14" DIAMETER
ESPECIALLY USEFUL FOR TONING PROBLEM AREAS SUCH AS THE INNER AND OUTER THIGHS AND UPPER ARMS
DEVELOP STRENGTH FROM DEEP INSIDE THE BODY FOR A FITTER AND FIRMER YOU!

SOFT MOULDED HANDLES FOR COMFORTABLE USE.
COLOR OPTION: GREEN/PINK

SKU AR-4001-NL

IF YOU HAVE ANY QUESTIONS OR WOULD LIKE SOME VALUABLE ADVICE, PLEASE FEEL FREE TO CONTACT US.

WWW.SHUTRADE.COM.AU

YOGA BALANCE

SHUTRADING
AUSTRALIA BEST FITNESS SUPPLIER



LACROSSE BALL/ MASSAGE BALL, IN 4-PCS PACK

IT IS EASY TO USE AND CARRY IN YOUR BAG WHEN YOU WANT TO PLAY SPORT. GREAT FOR THE NECK, SHOULDERS, BACK, CHEST, PIRIFORMIS, BUTTOCKS OR CALVES. PROMOTES BODY FLEXIBILITY ENHANCES MUSCLE PERFORMANCE.
SIZE: DIAMETER APPROX. 6CM EACH BALL
SOLD IN 4PCS PACK.

 PACKAGE SIZE: 13CM X 13CM X 7CM // PACKAGE WEIGHT: 0.7KG

SKU MB-2001-NL



PRO-TECH ATHLETIC MASSAGE BALL

MULTI-DIRECTIONAL ROLL PROVIDES FOCUSED MASSAGE TO TARGET AREAS. IT REDUCES MUSCLE FATIGUE AND TIGHTNESS. IT PROMOTES FLEXIBILITY AND ENHANCES PERFORMANCE. PERFECT FOR DISTANCE ATHLETES AND THOSE AFFECTED BY DEEP TISSUE STRAIN. 12CM (5") DIAMETER HIGH DENSITY BALL PROVIDES AGGRESSIVE DEEP TISSUE MASSAGE TO IT BAND, HAMSTRING, QUADRICEPS, CALF AND MORE. GREAT FOR THE ATHLETE OF ALL SPORTS AND ABILITY LEVEL.

 PACKAGE SIZE: 15CM X 15CM X 15CM // PACKAGE WEIGHT: 0.5KG

SKU MB-2005-HC



DOUBLE LACROSSE BALL

IT IS EASY TO USE AND CARRY IN YOUR BAG WHEN YOU WANT TO PLAY SPORT. GREAT FOR THE NECK, SHOULDERS, BACK, CHEST, PIRIFORMIS, BUTTOCKS OR CALVES. PROMOTES BODY FLEXIBILITY ENHANCES MUSCLE PERFORMANCE.
SIZE: 12CM L X 7CM X 7CM

 PACKAGE SIZE: 12CM L X 7CM X 7CM // PACKAGE WEIGHT: 0.3KG

SKU MB-2002-NL



NEW MESSAGE STICK, BLUE OR PINK - LONG SIZE

MUSCLE ROLLER STICK TO EASE AND CONDITION MUSCLE SORENESS AND AID RECOVERY, REDUCE STIFFNESS AND PAIN BEFORE AND AFTER WORKOUTS, EXERCISE, RUNNING AND TRAINING. WITH REGULAR USE IMPROVE YOUR STRENGTH, CIRCULATION AND REDUCE RISK OF INJURY. COLOR AVAILABLE: BLUE / PINK

 PACKAGE SIZE: 55CM X 6CM X 6.5CM // PACKAGE WEIGHT: 0.85KG

SKU AB-7001-NL



FITNESS ESSENTIALS KIT

INCLUDED:
- 5X TUBE BANDS
- 2X HANDLES
- 2X ANKLE STRAPS
- 1X LOOP ANCHOR
- 3X LOOP BANDS
- 1X EXERCISE MAT
- 2X TRAVEL BAGS
- 1X SHAKER BOTTLE

 PACKAGE SIZE: 80CM X 30CM X 20CM // PACKAGE WEIGHT: 3KG

SKU MB-2004-NL



NEW MESSAGE STICK, BLUE OR PINK - SHORT SIZE

MUSCLE ROLLER STICK TO EASE AND CONDITION MUSCLE SORENESS AND AID RECOVERY, REDUCE STIFFNESS AND PAIN BEFORE AND AFTER WORKOUTS, EXERCISE, RUNNING AND TRAINING. WITH REGULAR USE IMPROVE YOUR STRENGTH, CIRCULATION AND REDUCE RISK OF INJURY. COLOR AVAILABLE: BLUE / PINK

 PACKAGE SIZE: 43CM X 6CM X 6.5CM // PACKAGE WEIGHT: 0.65KG

SKU AB-7002-NL

◀ IF YOU HAVE ANY QUESTIONS OR WOULD LIKE SOME VALUABLE ADVICE, PLEASE FEEL FREE TO CONTACT US.

WWW.SHUTRADE.COM.AU

LATEX RESISTANCE BANDS

MADE WITH THE HIGHEST QUALITY NATURAL RUBBER LATEX, OUR LATEX RESISTANCE BANDS HELP USERS REHABILITATE INJURIES, IMPROVE FUNCTIONAL LIVING, ENHANCE ATHLETIC PERFORMANCE, AND MAKES MEASURING PROGRESS AND ACHIEVING GOALS FOR FITNESS OR THERAPY EASY. THE RESISTANCE BANDS ARE EASY-TO-USE, CONVENIENT, PORTABLE, AND ARE AN EFFECTIVE ALTERNATIVE TO FREE WEIGHTS AND WEIGHT MACHINES. AVAILABLE IN 5 COLOR-CODED LEVELS OF PROGRESSIVE RESISTANCE. SIZE: 1.5 METER OR 2 METER LONG, 10CM (4") WIDE



1.5M/5LB	SKU: AB-4501-NL // SIZE: 150CM (L) X 15CM (W) X 0.25CM (H) // WEIGHT: 0.2KG
1.5M/10LB	SKU: AB-4502-NL // SIZE: 150CM (L) X 15CM (W) X 0.35CM (H) // WEIGHT: 0.2KG
1.5M/15LB	SKU: AB-4503-NL // SIZE: 150CM (L) X 15CM (W) X 0.45CM (H) // WEIGHT: 0.2KG
1.5M/20LB	SKU: AB-4504-NL // SIZE: 150CM (L) X 15CM (W) X 0.55CM (H) // WEIGHT: 0.2KG
1.5M/25LB	SKU: AB-4505-NL // SIZE: 150CM (L) X 15CM (W) X 0.65CM (H) // WEIGHT: 0.2KG
2.0M/5LB	SKU: AB-4601-NL // SIZE: 200CM (L) X 15CM (W) X 0.25CM (H) // WEIGHT: 0.2KG
2.0M/10LB	SKU: AB-4602-NL // SIZE: 200CM (L) X 15CM (W) X 0.35CM (H) // WEIGHT: 0.2KG
2.0M/15LB	SKU: AB-4603-NL // SIZE: 200CM (L) X 15CM (W) X 0.45CM (H) // WEIGHT: 0.2KG
2.0M/20LB	SKU: AB-4604-NL // SIZE: 200CM (L) X 15CM (W) X 0.55CM (H) // WEIGHT: 0.2KG
2.0M/25LB	SKU: AB-4605-NL // SIZE: 200CM (L) X 15CM (W) X 0.65CM (H) // WEIGHT: 0.2KG



IF YOU HAVE ANY QUESTIONS OR WOULD LIKE SOME VALUABLE ADVICE, PLEASE FEEL FREE TO CONTACT US.

WWW.SHUTRADE.COM.AU

AEROBIC STEP



AEROBIC STEP, BLACK/GREY COLOR

COMMERCIAL GYM GRADE STEP, 3-LEVEL STACKS DESIGN (11CM, 16CM, 21CM) HEIGHT IS ADJUSTABLE // EXTRA BENCH BLOCKS / LEVELS COULD BE ADDED // ADVANCED NON-SLIP DECKING // SUPPORT UP TO 300KG // EASILY ASSEMBLE AND EASY USE.

BENCH DIMENSIONS: 110CML X 41CMW X 21CMH
COLOR: GREY BOARD / BLACK BLOCKS

 PACKAGE SIZE: 110CM L X 42CM W X 21CM H, WEIGHT: 11KG

SKU AP-3001-NL



SMALL AEROBIC STEP

SMALL STEP 2-LEVEL STACKS DESIGN, HEIGHT IS ADJUSTABLE. ADVANCED NON-SLIP DECKING SUPPORT UP TO 100KG EASILY ASSEMBLE AND EASY USE. BENCH DIMENSIONS: H20 X L79.5 X W29.5CM
COLOR: BLACK BOARD / GREY BLOCKS

 PACKING SIZE: 80CM L X 30CM W X 20CM H, WEIGHT: 3KG

SKU AP-3005-NL



AEROBIC STEP WITHOUT RUBBER COVER

COMMERCIAL GYM GRADE STEP, 3-LEVEL STACKS DESIGN (11CM, 16CM, 21CM) HEIGHT IS ADJUSTABLE // EXTRA BENCH BLOCKS / LEVELS COULD BE ADDED // ADVANCED NON-SLIP DECKING, NO RUBBER TOP, SUPPORT UP TO 300KG // EASILY ASSEMBLE AND EASY USE.

BENCH DIMENSIONS: 110CML X 41CMW X 21CMH
COLOR: GREY BOARD / BLACK BLOCKS

 PACKAGE SIZE: 110CM L X 42CM W X 21CM H, WEIGHT: 11KG

SKU AP-3006-NL



PAIR OF BLOCK FOR AEROBIC

AEROBIC STEP EXTENSION / BLOCKS // SOLD IN PAIR
PAIR OF STEP RISERS // COLOR AVAILABLE: BLACK

 PACKAGE SIZE: 40CM X 40CM X 16CM // PACKAGE WEIGHT: 1KG

SKU AP-3003-NL

AEROBIC GYM BAR

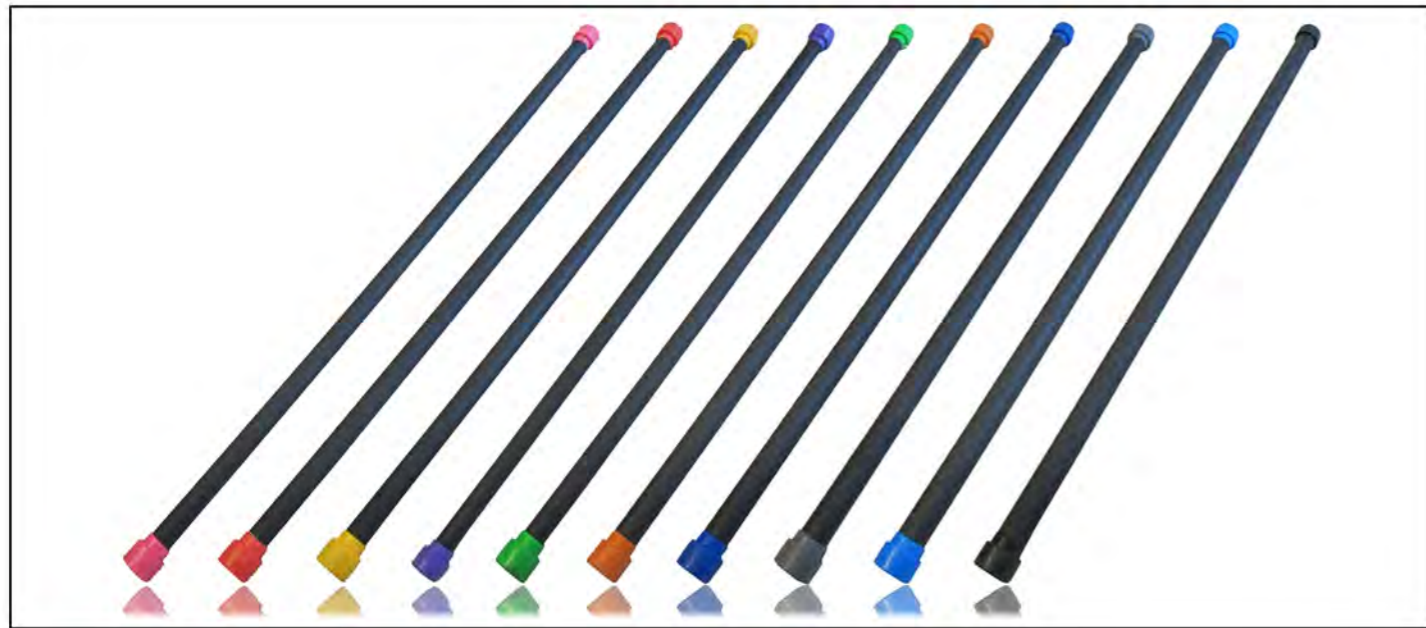

AEROBIC BAR / WEIGHTED GYM BODY BAR 1 - 10KG

THIS GYM AEROBIC BAR / WEIGHTED BODY BAR IS PERFECT FOR FITNESS ENTHUSIASTS AND SPORTSPERSON WHO ARE INTERESTED IN KEEPING THEIR ARMS AND LEGS IN SHAPE. GYM BAR HELPS IN STRENGTHENING THE CORE AND IS ALSO VERY EFFECTIVE FOR TONING THE ARMS AND LEGS.

THIS GYM WEIGHTED BAR IS AVAILABLE IN DIFFERENT WEIGHTS RANGING FROM 1KG TO 10KG. IDEAL FOR STRENGTHENING YOUR CORE, AND TONING ARMS AND LEGS.

LENGTH: 122CM

PACKAGE SIZE: 123CM X 6CM X 6CM

1KG	GB-2001-NL // PACKAGE WEIGHT: 1KG	7KG	GB-2007-NL // PACKAGE WEIGHT: 7KG
2KG	GB-2002-NL // PACKAGE WEIGHT: 2KG	8KG	GB-2008-NL // PACKAGE WEIGHT: 8KG
3KG	GB-2003-NL // PACKAGE WEIGHT: 3KG	9KG	GB-2009-NL // PACKAGE WEIGHT: 9KG
4KG	GB-2004-NL // PACKAGE WEIGHT: 4KG	10KG	GB-2010-NL // PACKAGE WEIGHT: 10KG
5KG	GB-2005-NL // PACKAGE WEIGHT: 5KG		
6KG	GB-2006-NL // PACKAGE WEIGHT: 6KG		



GYM BAR RACK

DESIGNED FOR EASY STORAGE OF YOUR BODY BARS, THIS RACK IS SIMPLE AND EFFECTIVE. VERTICAL STORAGE WITH 4 COMPONENTS FOR FITNESS BARS STORED IN A COMPACT SPACE WITH EASY ACCESS. HEAVY GAUGE STEEL PROVIDES A SOLID AND STABLE STORAGE SOLUTION. THE PERFECT COMPANION FOR YOUR BODY BARS / GYM FITNESS BARS, ITS COMPACT, STABLE AND AFFORDABLE.

ASSEMBLED SIZE: 51CM X 66CM X 97CM H

PACKAGE SIZE: 102CM X 53CM X 10CM
PACKAGE WEIGHT: 11.5KG

SKU

AS-5001-NL

VIBRATION FITNESS BAR



VIBRATION FITNESS BAR

VIBRATION BAR IS UNBEATABLE FOR ITS EFFECTIVENESS IN LOSING WEIGHT, TONING YOUR MUSCLES OR STRENGTHENING YOUR CORE. BECAUSE THE JOINFIT VIBRATION BAR UTILISES VIBRATION TRAINING TO WORK THE DEEP MUSCLES OF THE CORE, YOU CAN EXPECT TO FEEL DRAMATIC RESULTS, FAST! IF YOU ARE RECOVERING FROM AN INJURY, TRAINING FOR A PERFORMANCE SPORT, OR JUST INTERESTED IN IMPROVING YOUR FITNESS, JOINFIT VIBRATION BAR SHOULD BE YOUR TOP CHOICE.

THE VERSATILITY OF THE JOINFIT VIBRATION BAR PROVIDES YOU WITH HUNDREDS OF EXERCISES WHICH ALLOWS YOU TO TARGET ANY BODY PART YOU'D LIKE TO IMPROVE. IT'S A FANTASTIC TOOL USED BY EVERYONE TO IMPROVE GENERAL FITNESS AS WELL AS VERY SPECIFIC AREAS, INCLUDING WEIGHTLOSS, MOBILITY PROBLEMS, SPORTS TRAINING, INJURY REHABILITATION, BACK CARE AND CORE TRAINING. VIBRATION BAR CAN ALSO BE USED TO INCREASE YOUR OVERALL MUSCLE TONE AND STRENGTH.

IT'S THE MOST VERSATILE PIECE OF TRAINING EQUIPMENT YOU WILL EVER OWN, AND THE RESULTS YOU ACHIEVE WILL BE FASTER THAN WITH CONVENTIONAL MUSCLE METHODS OF TRAINING.

160CM SKU: JF-JC001BA // S.SIZE 23.5CM // PACKAGE SIZE: 160CM X 8CM X 8CM // WEIGHT: 0.7KG

160CM SKU: JF-JC001CA // M.SIZE: 23.5CM // PACKAGE SIZE: 160CM X 8CM X 8CM // WEIGHT: 0.7KG

140CM SKU: JF-JC001AB // L.SIZE: 19CM // PACKAGE SIZE: 140CM X 8CM X 8CM // WEIGHT: 0.6KG



IF YOU HAVE ANY QUESTIONS OR WOULD LIKE SOME VALUABLE ADVICE, PLEASE FEEL FREE TO CONTACT US.



NEW ADJUSTABLE CROSSFIT SKIPPING ROPE

ABSORB SWEAT NON-SLIP HANDLE, EASY FOR USE AND GREAT SPEED. EXCELLENT QUALITY MATERIAL, TESTED FOR STRENGTH AND ENDURANCE. INCLUDED SKIPPING ROPE, EXTRA ROPE WIRE AND FIXING SCREWS AND CARRY BAG.

STEEL ROPE LENGTH: 3 METER, IT IS ADJUSTABLE

PACKAGE SIZE: 19CM X 13CM X 4CM // PACKAGE WEIGHT: 0.5KG

SKU AR-2300-HC



STEEL SKIP ROPE

PROFESSIONAL STEEL WIRE SKIPPING ROPE WITH PRECISION BALL BEARINGS. ADJUSTABLE LENGTH STEEL WIRE CORE CABLE COVERED IN PVC, UNIQUE IN DESIGN.

STEEL WIRE COVERED IN PVC

ROPE LENGTH: 3 METRES

ADJUSTABLE LENGTH

PACKAGE SIZE: 19CM X 13CM X 4CM // PACKAGE WEIGHT: 0.5KG

SKU AR-2004-NL



LEATHER JUMP ROPE

IDEAL FOR SHEDDING WEIGHT FAST, TONING UP AND MAINTAINING MUSCLE TONE.

SKIPPING ROPES ARE AN EXCELLENT TOOL FOR ANY FITNESS LEVEL OR GOAL.

LEATHER ROPE LENGTH: 2.9 METER

PACKAGE SIZE: 21CM X 15CM X 4CM // PACKAGE WEIGHT: 0.5KG

SKU AR-2001-NL



STEEL SKIP ROPE WITH STEEL HANDLE

PROFESSIONAL STEEL WIRE SKIPPING ROPE WITH STEEL HANDLE & PRECISION BALL BEARINGS. ADJUSTABLE LENGTH STEEL WIRE CORE CABLE COVERED IN PVC, UNIQUE IN DESIGN.

STEEL WIRE COVERED IN PVC

ROPE LENGTH: 3 METRES

ADJUSTABLE LENGTH

PACKAGE SIZE: 19CM X 13CM X 4CM // PACKAGE WEIGHT: 0.5KG

SKU AR-2014-NL



PVC SKIP ROPE, BLUE

GREAT VALUE PREMIUM QUALITY PVC SKIPPING ROPE. SPECIALLY DESIGNED FOR SPEED JUMPING, UNIQUE IN DESIGN.

PACKAGE SIZE: 21CM X 15CM X 4CM // PACKAGE WEIGHT: 0.5KG

WHITE AR-2013-BL



SPORT SAFETY CONE

GREAT FOR VIRTUALLY ALL SPORTS.
BRIGHT ORANGE COLOR
MADE FROM HIGH QUALITY MATERIAL FOR DURABILITY
DESIGNED FOR USE ON ANY SURFACE- GRASS, CEMENT, ARTIFICIAL TURF AND MORE
6PCS PER PACK
SIZE AVAILABLE: 6" (15CM), 9" (23CM) & 12" (30CM)

15CM AC-3006-NL **23CM** AC-3009-NL **30CM** AC-3012-NL

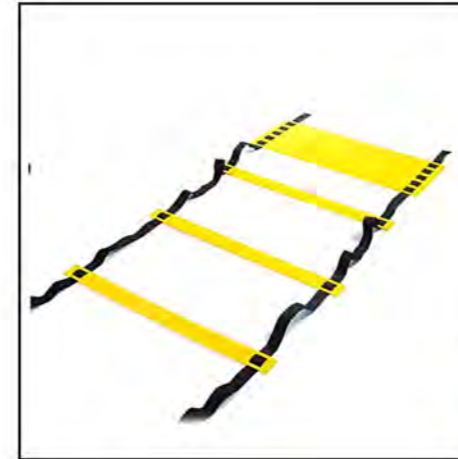

AGILITY SPEED LADDER

SPEED LADDERS, ALSO CALLED AGILITY LADDERS, ARE PIECES OF ATHLETIC EQUIPMENT TO HELP YOU TRAIN TO MOVE YOUR FEET FASTER. IMAGINE A LADDER LYING FLAT ON THE GROUND, TYPICALLY MADE OF FLAT ROPE (SO YOU DON'T TRIP AND INJURE YOURSELF).
LENGTH: 4M / 8M

 PACKAGE SIZE: 400/800CM X 45CM // PACKAGE WEIGHT: 1KG

4M AL-1001-NL **8M** AL-1002-NL



SPEED HURDLE

QUALITY MOULDED PLASTIC. NO METAL PARTS. LIGHT-WEIGHT, PORTABLE CONSTRUCTION. EASILY CARRIED AND STACKED.
HEIGHT: 30CM / 23CM / 15CM

 PACKAGE SIZE: 30/23/15CM X 45CM // PACKAGE WEIGHT: 0.4KG

15CM AH-2006-NL **23CM** AH-2009-NL **30CM** AH-2012-NL



SPORTS CONE SET (40PCS PER SET)

THIS CONE SET IS PERFECT FOR A WIDE VARIETY OF FITNESS PROFESSIONALS. IT IS USED BY PERSONAL TRAINERS, SOCCER AND FOOTBALL CLUBS, AND GROUP FITNESS TRAINERS JUST TO NAME A FEW. IT FEATURES A PAINTED RUSTPROOF HOLDER AND COMES IN A VARIETY OF BRIGHT COLOUR.
19CM HEIGHT; DIAMETER: 20CM; (1PC IS 5CM HEIGHT)

 PACKAGE SIZE: 21CM X 21CM X 20CM // PACKAGE WEIGHT: 1.2KG

MIX AC-3100-NL



BOXING TRAINING SET

LIGHT WEIGHT BUT POWERFUL: FABRIC PROTECTOR AND STRONG LATEX TUBE. SOFT PADS FOR COMFORT AND SAFETY USE. FOR BOXING, BASKETBALL, VOLLEYBALL AND FOOTBALL SPORTS TRAINING. ALSO FOR THOSE PEOPLE WHO HAVE SPECIAL RESISTANCE TRAINING NEEDS THAT INVOLVE ARMS, LEGS, AND LOWER BACK.

 PACKAGE SIZE: 30CM X 20CM X 10CM // PACKAGE WEIGHT: 1KG

SKU JF-JR021



MULTI-FUNCTION RESISTANCE TRAINING STICK

RESISTANCE TRAINING STICK EMPLOYS AN INNOVATIVE RESISTANCE CORD SYSTEM TO CREATE A VARIABLE, UNBALANCED LOAD THAT ENABLES YOU TO DEVELOP CORE STRENGTH, EXPLOSIVE POWER, FLEXIBILITY AND ENDURANCE. THE RESISTANCE TRAINING STICK IS EASILY PORTABLE AND USED TO INCREASE THE ROTATIONAL BODY STRENGTH, EXPLOSIVE POWER, CORE STABILITY AND FUNCTIONAL TRAINING.

 PACKAGE SIZE: 57.5CM X 8CM X 9CM // PACKAGE WEIGHT: 2.5KG

SKU JF-JC004B



FITNESS GILDER, GYM SLIDER SET

FITNESS GLIDER, ALSO CALLED GYM SLIDER, IS USED TO GLIDE SMOOTHLY ACROSS A CARPET OR SMOOTH SURFACE TO ADD EXTRA HEAT TO YOUR WORKOUTS. IT HELPS YOU INCREASE STABILITY TO OPTIMISE THE RANGE OF MOTION, AND INCREASE MUSCLE TONE BY WORKING MULTIPLE MUSCLES AT ONCE, PLUS INCREASING YOUR CORE STRENGTH.

THIS SET INCLUDES:

2 X GLIDERS 2 X GLIDER COVERS 1 X CARRY BAG

 PACKAGE: 30CM L X 16CM W X 5CM H. WEIGHT: 1KG

SKU AG-9001-NL



FITNESS GILDER, GYM SLIDER SET

FITNESS GLIDER, ALSO CALLED GYM SLIDER, IS USED TO GLIDE SMOOTHLY ACROSS A CARPET OR SMOOTH SURFACE TO ADD EXTRA HEAT TO YOUR WORKOUTS. IT HELPS YOU INCREASE STABILITY TO OPTIMISE THE RANGE OF MOTION, AND INCREASE MUSCLE TONE BY WORKING MULTIPLE MUSCLES AT ONCE, PLUS INCREASING YOUR CORE STRENGTH.

THIS SET INCLUDES:

2 X GLIDERS 2 X GLIDER COVERS 1 X CARRY BAG

 PACKAGE: 30CM L X 16CM W X 5CM H. WEIGHT: 1KG

SKU AG-9001-NL

ACCESSORIES



POWER HAND GRIPS, 100LB - 250LB

TOP QUALITY HAND GRIPS. MADE FROM CHROME STEEL
THIS HAND GRIP IS VERY DURABLE
PULL STRENGTH AVAILABLE: 100LB, 150LB, 200LB & 250LB

PACKAGE SIZE: 21CM X 14CM X 2.5 CM // PACKAGE WEIGHT: 0.3KG

100 LB AG-1001-NL **200 LB** AG-1003-NL

150 LB AG-1002-NL **250 LB** AG-1004-NL



ADJUSTABLE HAND GRIPS

TPR HANDLE, GOOD ELASTICITY, PREVENT SLIPPERY DESIGN.
HIGH QUALITY STEEL, NOT RUSTING.
FREE TO ADJUST THE GRIP SIZE. AND STRENGTH TENSION FROM 5KG – 20KG.

PACKAGE SIZE: 21CM X 17CM X 4CM , WEIGHT: 0.5KG

SKU AG-2001-NL



GYM CHALK

HIGH QUALITY MAGNESIUM CHALK
SUITABLE FOR GYM, WEIGHT LIFTING, KETTLEBELLS, ROCK CLIMB, ETC.
ONE BOX WITH 8 BLOCKS. 60G/EACH BLOCK AND 480G IN TOTAL

PACKAGE SIZE: 18CM X 18CM X 9CM // PACKAGE WEIGHT: 0.6KG

SKU AC-1001-NL



FOLDABLE MINI TRAMPOLINE/REBOUNDER

ADJUSTABLE AND PADDED HANDRAIL FOR EASY GRIP, THE JUMPING REBOUNDING MAT IS MADE OF STRONG PP MESH MAT, STABLE BOUNCING PERFORMANCE. ADJUSTABLE & REMOVABLE T-SHAPED HANDLE, EASY TO CARRY AND STORE THE TRAMPOLINE. EMPLOYS BUNGEE ROPES AS ELASTIC DEVICES WHICH IS NOTICEABLY SAFER THAN TRADITIONAL METAL SPRING. CONVENIENCE AND EASY ASSEMBLE
MAXIMUM LOAD: 150KG

PACKAGE SIZE: 100CM X 40CM X 15 CM // PACKAGE WEIGHT: 5KG



PLANK AB ROLLER

THE EXTRA SUPPORT AB ROLLER / ABDOMINAL WHEEL IS MORE FRIENDLY TO BEGINNERS. IT FEATURES ERGONOMIC HAND GRIPS AND ELBOW SUPPORTS THAT MINIMIZE THE INVOLVEMENT OF ARM MUSCLES WHILE REMAINING COMFORTABLE AND STABLE, FOCUS CAN THEN BE PUT ON CHALLENGING YOUR CORE MUSCLES INSTEAD OF SPENDING ARMS STRENGTH TO HOLD ON TO OTHER REGULAR AB ROLLERS IN THE MARKET.

PACKAGE SIZE: 35CM X 35CM X 30CM , WEIGHT: 2KG

SKU AW-1100-NL



PUSH UP BOARD RACK SYSTEM

13 IN 1 UPGRADED DESIGN, PUSH UP BAR WITH RESISTANCE BAND HELPS TO SCULPT AND MAXIMIZE YOUR CHEST, BUTTOCK, SHOULDERS, BACK, AND TRICEPS. DIFFERENT COLOR TARGETS SPECIFICS MUSCLES (BLUE-CHEST, RED-SHOULDERS, YELLOW-BACK, AND GREEN-TRICEPS)

PACKAGE SIZE: 70CM X 20CM X 9CM // PACKAGE WEIGHT: 1KG

SKU

ACCESSORIES



TIBIALIS TRAINING BAR

THIS TIBIALIS ANTERIOR MACHINE IS WITH HAVE A STRONG STEEL CONSTRUCTION THAT IS INCREDIBLY DURABLE AND IDEAL FOR HOME AND COMMERCIAL USE. WE HIGHLY RECOMMEND USING THIS AS PART OF YOUR WORKOUT REGIMEN.

MATERIAL: HEAVY GAUGE, WELDED, SOLID STEEL

CAPACITY: 70KG

FITTING FOR BOTH 2" OLYMPIC / 1" STANDARD WEIGHT PLATES

ACCESSORIES: 1X BARBELL CLAMPS AND TOOL

APPLICATION: LEG, ABDOMINAL MUSCLES AND BICEPS TRAINING

 **PACKAGE SIZE: 40CM X 30CM X 30CM // PACKAGE WEIGHT: 3KG**

SKU EB-TB001-NL



TIBIALIS TRAINING BAR, SOLO

VERSATILE EQUIPMENT: STRENGTHEN YOUR TIBIALIS, KNEES, SHINS AND ANKLES BY USING THE ADJUSTABLE, SINGLE FOOT TIB BAR EQUIPMENT TO HELP YOU IMPROVE BALANCE, RUN FASTER, JUMP HIGHER, WALK WITHOUT PAIN, IMPROVE ATHLETIC PERFORMANCE AND PREVENT INJURIES.

EASY SETUP: ADJUSTABLE TIBIALIS MACHINE COMES WITH A BARBELL COLLAR TO SECURE 2-INCH OLYMPIC PLATES WITH EASE. ENSURE THE WEIGHT PLATES ARE PUSHED UP AGAINST THE COLLAR AND SECURED TIGHTLY WITH THE LOCKING CLAMP BEFORE ENGAGING IN YOUR EXERCISES.

 **PACKAGE SIZE: 40CM X 30M X 25CM // PACKAGE WEIGHT: 2KG**

SKU EB-TB002-NL

ACCESSORIES



NYLON HEAD HARNESS

NYLON HEAD HARNESS NYLON HEAD HARNESS RECOMMENDED FOR ALL ATHLETES AND SPECIFICALLY DESIGNED FOR THOSE IN CONTACT SPORTS, HEAD HARNESSES CONDITION THE NECK AND UPPER BACK MUSCLES. FEATURES INCLUDE THE FINEST QUALITY MATERIALS, EXTRA-HEAVY D RINGS AND STEEL CHAIN. COMPLETELY PADDED WITH HIGH DENSITY NEOPRENE TO ABSORB SHOCK AND PREVENT CUTS, CHAFING AND ABRASION. USE THEM WITH FREE WEIGHTS OR HOOK THEM TO A HIGH OR

PACKAGE SIZE: 15CM X 15CM X 5CM // PACKAGE WEIGHT: 0.8KG

SKU AH-5001-NL



NYLON DIPPING BELT

THE DIP BELT IS A KEY TOOL USED TO TRAIN GYM STRENGTH. IT ALLOWS FOR A HIGHER LOAD CAPACITY, EASY ADJUSTMENTS, AND RELIABLE SAFETY UNDER EXTREME TENSION. ALSO, IT COMES EQUIPPED WITH A REINFORCED, COMFORT-FIT NYLON BODY WITH HEAVY STITCHING AVAILABLE IN BLACK, A 80CM TOTAL CHAIN LENGTH, AND A PAIR OF STRAIGHT-GATE, LOCKING CARABINERS.

PACK SIZE: 50CM L X 17CM W X 3CM, WEIGHT: 0.5KG

SKU AB-6002-NL



LEATHER HEAD HARNESS

THIS HEAD HARNESS IS MADE OF DURABLE LEATHER. EXTRA WIDE SUPPORT FOR ADDED COMFORT. CAN BE ADJUSTED TO SUIT YOUR HEAD. EFFECTIVELY STRENGTHEN THE NECK AND SHOULDER POWER.

PACKAGE SIZE: 21CM X 14CM X 2.5 CM // PACKAGE WEIGHT: 0.3KG

SKU AH-5002-NL



LEATHER DIPPING BELT

WITH A NEW DESIGN, THE BELT IS MADE FROM COWHIDE LEATHER WITH A SUEDE BACKING. THE NEWLY WIDENED BELT ENSURES THE LOAD IS SPREAD EVENLY, AVOIDING ANY UNNECESSARY LOADING TO THE LOWER BACK. ALSO, IT IS ALSO ADDED EXTRA PADDING TO MAKE ADDING WEIGHT ACCEPTABLE AND AN EXTRA LONG CHAIN

PACK SIZE: 50CM L X 17CM W X 3CM, WEIGHT: 0.5KG

SKU AB-6003-NL



ARM BLASTER

LIGHT WEIGHT METAL CONSTRUCTION ADJUSTABLE NYLON NOCK HANGING STRAP CUSHIONED ARM REST POSITION IDEAL SUPPORT SYSTEM FOR BICEPS MUSCLE
SIZE: 21.5 INCH LONG

PACKAGE SIZE: 55CM X 14CM X 14CM // PACKAGE WEIGHT: 1KG

SKU EA-9102-NL



PADDED NYLON AB SLINGS

THESE SLINGS ENCOURAGE SUPERIOR TONING, TRIMMING AND CONDITIONING OF THE ENTIRE ABDOMINAL AREA WITHOUT LOWER BACK STRAIN. IN FACT, THEY CAN ACTUALLY HELP ABAD BACK BY STRETCHING THE MUSCLES AND DECOMPRESSING THE SPINE. FEATURES INCLUDE SOLID STEEL FIRE AND RESCUE LOCKING CARABINERS THAT ARE RATED AT 10,000 LBS. CAPACITY EACH. ARM SLINGS ARE 19CM WIDE WITH DENSE AND DURABLE 1CM THICK PADS. WEIGHT: 750G PER PAIR SOLD IN PAIR

PACKAGE SIZE: 55CM X 14CM X 14CM // PACKAGE WEIGHT: 1KG

SKU EA-9003-NLL

ACCESSORIES



AB MAT WITH TAILBONE PROTECTING PAD

THIS AB MAT ENABLES FULL RANGE OF MOTION TO WORK YOUR ENTIRE CORE. WITH NO SLIP TAILBONE PROTECTION PAD, HELPS TO STAY IN PLACE DURING WORKOUT. ITS ERGONOMIC DESIGN SUPPORTS THE LUMBAR REGION OF THE BACK. AND QUALITY MATERIALS MAINTAIN FORM AND SUPPORT THROUGH REPEATED USE.

 PACKAGE SIZE: 10CM X 40CM X 30CM

 SKU AH-5002-NL



EXERCISE WHEEL

THE ABDOMINAL EXERCISE WHEEL IS AN EXCELLENT WAY IN WHICH TO OBTAIN A MORE TONED SET OF ABS. STEEL ROD THROUGH THE MIDDLE AND WITH DOUBLE WHEELS. WELL DESIGNED HANDGRIP. PORTABLE AND EASY TO USE AT HOME OR IN THE GYM.

 PACKAGE SIZE: 26CM X 23CM X 5.5CM, WEIGHT: 0.6KG

 SKU AW-1002-HC



AB CORE SITUP MAT / AB CORE PAD

THE ABCORE PAD IS ONE OF THE MOST EFFECTIVE TRAINING PADS AVAILABLE ON THE MARKET. IT OFFERS: THE FULL RANGE OF MOTION NECESSARY WHICH ALLOWS YOU TARGET ALL OF YOUR ABDOMINAL MUSCLE GROUPS;
A VARIETY OF EXERCISES CAN BE DONE TO ACHIEVE DIFFERENT GOALS;
CAN BE USED TO ISOLATE UPPER OR LOWER ABS, AS WELL AS TARGETING THOSE HARD TO TRAIN OBLIQUES;
THE AB CORE PAD IS A SAFE, COMFORTABLE DESIGN WHICH FITS SNUGGLY TO THE CONTOUR IN YOUR LOWER BACK;

 PACKAGE SIZE: 36CM X 30CM X 7CM // PACKAGE WEIGHT: 1KG

 SKU AM-5001-NL



PUSH UP BARS

OUR DELUXE PUSH UP STANDS ALLOW FOR A GREATER RANGE OF MOTION, GIVING YOU BETTER AND MORE EFFICIENT DEVELOPMENT OF THESE MUSCLE GROUPS. DURABLE MOLDED PLASTIC BARS WITH STEEL HANDLE
CUSHIONED FOAM GRIPS
NON-SKID REMOVABLE BASES
ONE PAIR PER SET

 PACKAGE SIZE: 26CM X 17CM X 8 CM, WEIGHT: 1.5KG

 SKU AB-1001-HC



40 INCH MINI TRAMPOLINE

RUGGED, ALL STEEL FRAME CONSTRUCTION.
COMES WITH BLUE SAFETY COVER
EASY STORAGE, SAFETY PAD, HEAVY DUTY REBOUNING SURFACE
MAX SUPPORT WEIGHT IS 110KG
DIAMETER IS: 40"

 PACKAGE SIZE: 105CM X 105CM X 6CM, WEIGHT: 8KG

 SKU AT-1040-NL

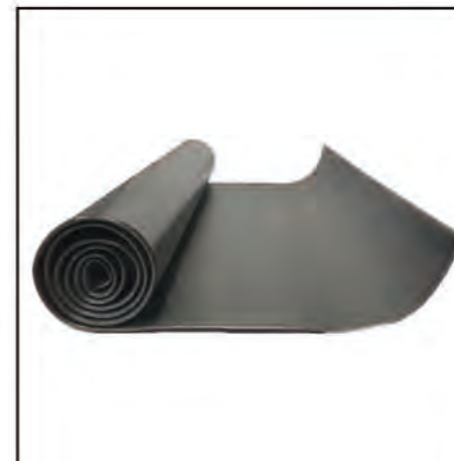

TREADMILL MAT

DURABLE EXPANDED VINYL
PERFECT FOR TREADMILLS, STEPPERS, AND ELLIPTICALS
PROTECT YOUR FLOOR & EQUIPMENT
MAT SIZE: 200CM X 100CM X 0.6CM

 PACKAGE SIZE: 100CM X 20CM X 20CM, WEIGHT: 5.5KG

 SKU AM-4001-NL

STORAGE RACK



SINGLE-SIDE MEDICINE BALL STAND, HOLD 5 BALLS

THIS SINGLE-SIDE MEDICINE BALL RACK CAN HOLD 5 BALLS. IT IS EASY TO ASSEMBLE.

ASSEMBLY SIZE: 45CM L X 33CM W X 139CM H
WEIGHT RATING: 50KG

 PACKAGE SIZE: 139CM X 34CM X 10CM // PACKAGE WEIGHT: 10KG

SKU AS-1100-NL



2-TIERS DUMBBEL RACK, WITH SADDLE

COMMERCIAL GRADE DUMBBELL STORAGE RACK INCLUDES CUP HOLDERS,
CARRIES 10 PARIS FIXED ROUND DUMBBELLS
WEIGHT RATING: 1000KG
ASSEMBLED SIZE: 230CM X 79CM X 55CM

 PACKAGE SIZE: (C1) 90CM X 85CM X 12CM // PACKAGE WEIGHT: 20KG
(C2) 108CM X 27CM X 12CM // PACKAGE WEIGHT: 40KG

SKU AS-3001-NL



DOUBLE-SIDE MEDICINE BALL STAND, HOLD 10 BALLS

THIS DOUBLE-SIDE MEDICINE BALL RACK CAN HOLD 5 BALLS. IT IS EASY TO ASSEMBLE.

ASSEMBLY SIZE: 45CM L X 33CM W X 139CM H
WEIGHT RATING: 90KG

 PACKAGE SIZE: 139CM X 34CM X 10CM // PACKAGE WEIGHT: 10KG

SKU AS-1200-NL



VERTICAL DUMBBELL RACK (10 PAIRS)

VERTICAL DUMBBELL RACK, 10 PAIRS
THIS RACK CAN HOLD 1KG TO 10KG, 10 PAIR DUMBBELL
BLACK COLOR CYLINDER WITH CHROME TOP CAP
SIZE: 50CM WIDE X 55CM DEEP X 123CM HIGH
PACK: FLAT PACKED IN BOX

 PACKAGE SIZE: 124CM X 52CM X 25 CM // PACKAGE WEIGHT: 22KG

SKU AS-3002-NL



2 LAYER KETTLEBELL RACK

2-LAYER KETTLEBELL RACK (152L X 50W X 75 HCM)

BLACK COLOR

WEIGHT RATING: 500KG

ASSEMBLED SIZE: 50CM X 152CM X 75CM

 PACKAGE SIZE: 71CM X 51CM X 16CM // PACKAGE WEIGHT: 35KG

SKU AS-2001-NL



TRIANGLE DUMBBELL RACK (10 PAIRS)

TRIANGLE DUMBBELL RACK HOLDS 10 PAIR OF DUMBBELLS
OFFERS MAXIMUM DURABILITY AND BETTER PERFORMANCE IN LESS SPACE
DIMENSION: 65CM X 55CM X 145CM H
PACK: FLAT PACKED IN BOX

 PACKAGE SIZE: 127CM X 15CM X 5 CM ,WEIGHT: 17KG

SKU AS-3003-NL

STORAGE RACK



3-TIERS DUMBBELL RACK

3 TIERS DESIGN
HEAVY GAUGE STEEL WITH ALL 4-SIDE WELDED CONSTRUCTION
DIMENSIONS: 1320MM(L) X 460MM(W) X 950MM(H)
PACKAGE: ONE RACK IN 2 FLAT BOXES

BOX1 SIZE: 124CM X 33CM X 17 CM // PACKAGE WEIGHT: 28KG
BOX2 SIZE: 97CM X 50CM X 11CM // PACKAGE WEIGHT: 10KG

SKU AS-3005-NL



OLYMPIC WEIGHT & BARBELL RACK (2-BARS)

COMMERCIAL GRADE OLYMPIC BARBELL AND PLATE STORAGE RACK INCLUDES
2X BARBELL HOLDERS AND 6 ARMS FOR OLYMPIC PLATES

ASSEMBLED SIZE: 135CM X 50CM X 55CM

PACKAGE SIZE: 140CM X 40CM X 25CM // PACKAGE WEIGHT: 20KG

SKU AS-3006-NL



MINI RACK FOR 3 PAIRS OF VINYL/NEO. DUMBBELL

HARDCASTLE BODYBUILDING SMALL DUMBBELL WEIGHT RACK, IDEAL STORAGE FOR
MINI & HEX DUMBBELL WEIGHTS, SMALL/COMPACT SIZE FOR FLOORS & TABLETOPS —
KEEPS WORKOUT AREAS NEAT & CLUTTER FREE, HOLDS UP TO 6, DUMBBELLS/3 PAIRS
— STRONG PLASTIC CONSTRUCTION
WIDTH: 34CM — DEPTH: 9CM — HEIGHT: 34CM

SKU AS-3011-NL

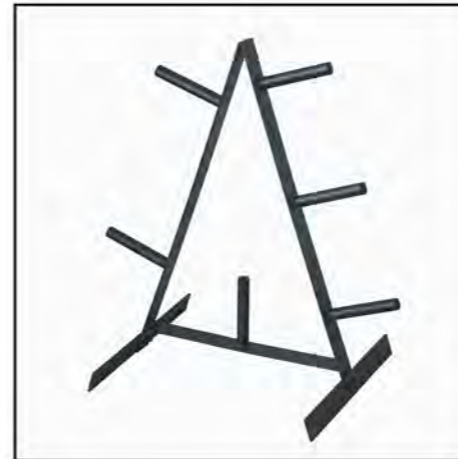

TRIANGLE STANDARD PLATE TREE

EASY TO ASSEMBLE METAL CONSTRUCTION FITS STANDARD 25MM WEIGHT PLATE. 6
STORAGE SPOKES
WEIGHT RATING: 250KG
ASSEMBLED SIZE: 55CM X 50CM X 76CM

PACKAGE SIZE: 81CM X 59CM X 7CM, WEIGHT: 10KG

SKU AS-4003-NL



SMALL 2-LEVEL HEX DUMBBELL RACK

OVERALL HEIGHT - TOP TO BOTTOM: -77CM.
OVERALL WIDTH - SIDE TO SIDE: -72CM.
OVERALL DEPTH - FRONT TO BACK: 50CM
TOTAL STORAGE LENGTH: 132CM (66CM PER TIER)
WEIGHT CAPACITY: 250KG
FITS FOR DUMBBELLS WITH AN INTERNAL HANDLE LENGTH OF 5 INCHES OR LONGER

PACKAGE SIZE: 83CM X 25CM X 10CM H, WEIGHT: 14KG

SKU AS-3012-NL



TRIANGLE OLYMPIC PLATE TREE

EASY TO ASSEMBLE METAL CONSTRUCTION FITS STANDARD 25MM WEIGHT
PLATE. 5 STORAGE SPOKES
WEIGHT RATING: 250KG
ASSEMBLED SIZE: 75CM X 54CM X 84CM

PACKAGE SIZE: 89CM X 69CM X 7CM, WEIGHT: 11KG

SKU AS-4004-NL

STORAGE RACK



STANDARD PLATE TREE WITH HOLDER

EASY TO ASSEMBLE METAL CONSTRUCTION, EXTRA SUPPORT TO STRENGTHEN THE RACK CAPABILITY, ADJUSTABLE HEAVY DUTY STEEL TUBIN, FITS STANDARD 28MM WEIGHT PLATE, 6 STORAGE SPOKES, HIGH QUALITY DARK GREY METALLIC POWDER COATING.

WEIGHT RATING: 350KG

ASSEMBLED SIZE: 70CM X 61CM X 115CM H

PACKAGE SIZE: 118CM X 38CM X 13CM , WEIGHT: 12KG

SKU AS-4005-NL



OLYMPIC PLATE TREE WITH HOLDER

EASY TO ASSEMBLE METAL CONSTRUCTION, EXTRA SUPPORT TO STRENGTHEN THE RACK CAPABILITY, ADJUSTABLE HEAVY DUTY STEEL TUBIN, FITS STANDARD 50MM WEIGHT PLATE, 6 STORAGE SPOKES, HIGH QUALITY DARK GREY METALLIC POWDER COATING.

WEIGHT RATING: 350KG

ASSEMBLED SIZE: 72CM X 61CM X 115CM H

PACKAGE SIZE: 118CM X 43CM X 13CM // PACKAGE WEIGHT: 13KG

SKU AS-4006-NL



BUMPER PLATE RACK, HORIZONTAL (NEW DESIGN)

THE HORIZONTAL BUMPER PLATE RACK, ALSO CALLED AS TOASTER RACK, IS THE PERFECT STORAGE SOLUTION FOR ANY STYLE OF BUMPER PLATES.

WITH A HANDLE AND WHEELS, MOVING PLATES AROUND CAN BE MUCH EASIE

ASSEMBLED SIZE: 130CM X 50CM X 40CM H

PACKAGE SIZE: 120CM X 38CM X 11CM ,WEIGHT: 11KG

SKU AS-4100-NL



OLYMPIC SIZE BAR HOLDER — 10 HOLES

TRIANGLE DUMBBELL RACKHOLDS 10 PAIR OF DUMBBELLS.

OFFERS MAXIMUM DURABILITY AND BETTER PERFORMANCE IN LESS SPACE.

FEATURES AND SPECIFICATIONS:

DIMENSION: 132CM X 52CM X 32CM PACKAGE CONTENT

PACKAGE SIZE: 127CM X 26CM X 13 CM // PACKAGE WEIGHT: 8KG

SKU AS-4210-NL



VERTICAL BUMPER PLATE RACK WITH WHEEL

DOLLY WHEELS FOR MOBILITY

HEAVY DUTY CONSTRUCTION WITH THICK METAL PLATE

ASSEMBLED SIZE: 69CM X 120CM H (VERTICAL POST 90CM H)

PACK SIZE: 51CM X 29CM X 138CM H ,WEIGHT: 11KG

SKU AS-4102-NL



OLYMPIC SIZE BAR HOLDER — 9 HOLES

MADE FROM SOLID STEEL

PERFECT IF YOU WANT TO KEEP YOUR BARS OFF THE FLOOR OR HAVE YOUR DELUXE BARS IN A SPECIAL HOLDER.

FIT MAXIMUM 9 OLYMPIC BARS.

ASSEMBLED SIZE: 48CM X 48CM X 18.5CM

PACKAGE SIZE: 160CM X 44CM X 7CM // PACKAGE WEIGHT: 10KG

SKU AS-4200-NL

STORAGE RACK



BARBELL RACK (9 HOLE VERTICAL)

THE OLYMPIC 9 HOLE BARBELL RACK CAN SAVE SPACE IN YOUR HOME GYM BY UTILISING THIS VERTICAL STORAGE STAND FOR OLYMPIC SIZED BARBELLS. IT HAS THE CAPACITY FOR 9 BARS AND IS COMPACT ENOUGH TO FIT IN ANY CORNER OR DEAD SPACE FOR EFFICIENT STORAGE. FULLY UTILISE ALL THE AVAILABLE SPACE FOR AN OPTIMISED GYM
SIZE: 46 X 47 X 20CM - 28KG

 PACKAGE SIZE: 50CM X 50CM X 25CM // PACKAGE WEIGHT: 29KG

SKU AS-4230-NL



ULTIMATE STORAGE RACK #02 (LONG RACK ONLY)

IF YOUR GYM NEED A WAY TO KEEP YOUR FUNCTIONAL EQUIPMENT STORED IN A CONVENIENT RACK, OUR ULTIMATE STORAGE RACK' IS THE ANSWER! IF YOU'RE LOOKING TO STORE KETTLEBELLS, DUMBBELLS, MEDICINE BALLS, WALL BALLS, FOAM ROLLERS, WEIGHT BAGS, THIS RACK PROVIDES THE SOLUTION.
WEIGHT: HEAVY
PACKAGE QTY: DIFFERENT PARTS IN SEVERAL CARTONS

 PACKAGE SIZE: VARIOUS

SKU AS-7002-NL



GYM BAR RACK

DESIGNED FOR EASY STORAGE OF YOUR BODY BARS, THIS RACK IS SIMPLE AND EFFECTIVE. VERTICAL STORAGE WITH 4 COMPONENTS FOR FITNESS BARS STORED IN A COMPACT SPACE WITH EASY ACCESS. HEAVY GAUGE STEEL PROVIDES A SOLID AND STABLE STORAGE SOLUTION.

ASSEMBLED SIZE: 97CM X 51CM X 66CM

 PACKAGE SIZE: 102CM X 53CM X 10CM // PACKAGE WEIGHT: 11.5KG

SKU AS-5001-NL



ULTIMATE STORAGE RACK #01

IF YOUR GYM NEED A WAY TO KEEP YOUR FUNCTIONAL EQUIPMENT STORED IN A CONVENIENT RACK, OUR ULTIMATE STORAGE RACK' IS THE ANSWER! IF YOU'RE LOOKING TO STORE KETTLEBELLS, DUMBBELLS, MEDICINE BALLS, WALL BALLS, FOAM ROLLERS, WEIGHT BAGS, THIS RACK PROVIDES THE SOLUTION.
WEIGHT: HEAVY
PACKAGE QTY: DIFFERENT PARTS IN SEVERAL CARTONS

 PACKAGE SIZE: VARIOUS

SKU AS-7001-NL



BARBELL WALL RACK

BARBELL WALL RACK FEATURES PRECISION-BENT, 7-GAUGE STEEL BRACKETS AND A UNIQUE RUNG DESIGN THAT WILL SUPPORT EITHER THE SLEEVE OR THE SHAFT OF ANY STANDARD WEIGHT BAR. ATHLETES AND GYM OWNERS WHO ELECT TO INCLUDE THE PROTECTIVE PLASTIC LINERS WITH THEIR ORDER WILL ALSO RECEIVE THE NECESSARY HARDWARE FOR JOINING THE INSERTS TO THE RACK.

 PACKAGE SIZE: 140CM X 16CM X 9CM // PACKAGE WEIGHT: 13KG

SKU AS-4220-NL